

B

A

S

**SPOT
LIGHT**
BASIC COLLECTION

I

C



*...we
design
light*

SPOT LIGHT

BASIC COLLECTION

2020 - 2021

Nasza przygoda ze światłem trwa nieprzerwanie od 1996 roku – w tym czasie SPOT Light z małej, rodzinnej firmy rozwinął się w wiodącego producenta oświetlenia Europy Wschodniej, dostarczającego swoje produkty do 52 krajów na świecie.

W naszej siedzibie w Bierawie, w jednym z najnowocześniejszych kompleksów produkcyjno-magazynowych branży oświetleniowej, tworzymy produkty najwyższej jakości z komponentów europejskiego pochodzenia. Naszym najważniejszym surowcem pozostaje polskie drewno pochodzące z lasów spełniających standardy dobrej praktyki leśnej, opatrzone certyfikatem FSC®. Lampy z drewna dębowego, bukowego, brzozy i sosny o minimalistycznym designie stanowią trzon nowej BASIC Collection. Jej równie ważną częścią są oprawy oświetleniowe z ręcznie odlewanych elementów betonowych, czy doskonale wykonane abażury. Tworzymy piękne lampy dla ludzi ceniących wysoką jakość i funkcjonalność, dla których obcowanie z produktem o ponadczasowym designie, wykonanym z naturalnego surowca będzie źródłem radości przez wiele lat.

Zapraszamy do poznania BASIC Collection!

Our adventure with light has been going on continuously since 1996 – over the years SPOT Light has developed from a small, family company into a leading manufacturer of lighting in Eastern Europe, supplying its products to 52 countries in the world.

High quality is our priority - we create products from components of European origin in one of the most modern production facilities of the lighting industry, at our headquarters in Bierawa. Our most important material remains FSC® certified wood from Polish forests, that meet the standards of good forest practice. Minimalistic lamps made of oak, beech, birch and pine build the core of the new BASIC Collection. Its equally important part are luminaires made out of hand-cast concrete elements or perfectly crafted lamp shades. We create beautiful lamps for people who value high quality and functionality, appreciate good design and love to be surrounded by natural materials at its best.

We invite you to discover BASIC Collection!

Unser Abenteuer mit Licht dauert mittlerweile seit 1996 - im Laufe der Jahre hat sich SPOT Light von einem kleinen Familienunternehmen zu einem führenden Leuchtenhersteller in Osteuropa entwickelt, der seine Produkte in 52 Länder der Welt liefert.

Wir legen sehr großen Wert auf die eigene, hochqualitative Fertigung der Leuchten. So werden die zur Produktion verwendeten Komponenten ausschließlich in Europa beschafft. Der Werkstoff Holz, aus FSC® zertifizierter Forstwirtschaft, steht bei uns im Mittelpunkt. Minimalistische Leuchten aus Eiche, Buche, Birke und Kiefer bilden den Kern der neuen BASIC-Kollektion. Ebenso stark vertreten sind die Lampen mit handgegossenen Betonelementen oder perfekt angefertigten Lampenschirmen.

Wir entwickeln besondere Leuchten für Menschen, mit Vorlieben für modernes, designorientiertes Einrichten, die Wert auf hohe Qualität, Nachhaltigkeit und Funktionalität legen.

Wir laden Sie ein, die BASIC Collection zu entdecken!



**SPOT
LIGHT**
BASIC COLLECTION



...we
design
light



RAMME



1) 9142274

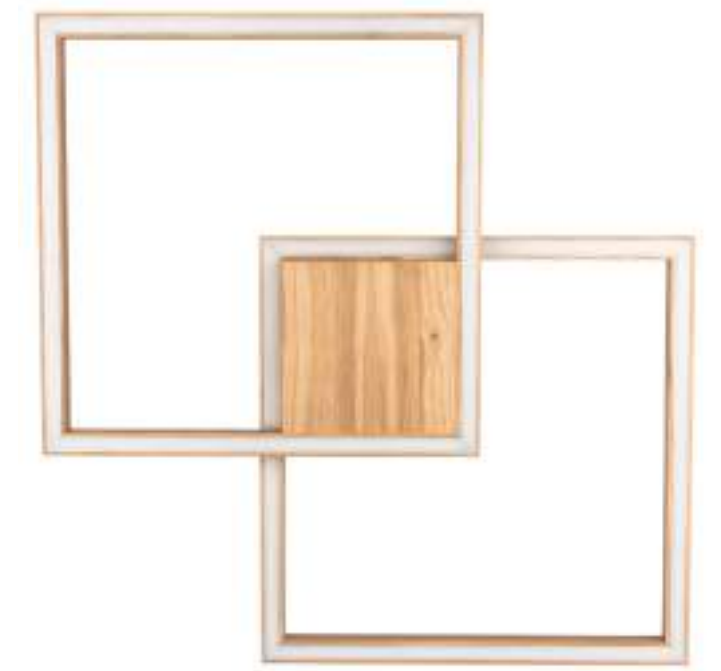

5) 9145274



3) 9141174

Przykładowa konfiguracja/Example configuration/Beispielkonfiguration

RAMME

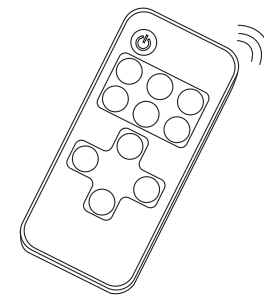

Ściemnianie pilotem
Dimming with remote control
Dimmen mit der Fernbedienung

Dostępne konfiguracje/Available configurations/Verfügbare Konfigurationen



RAMME

Wymiary Dimensions Maße	Lp. No. Lfd. Nr.	Nr art. Item No. Art.-Nr.	Pilot Remote control Fernbedienung	Kolor drewna Wood color Holzfarbe	Materiał Material Material	Źródło światła Light source Lichtquelle
	1	9142274	---	Dąb olejowany Oiled Oak Eiche geölt	Drewno dębowe/Akryl Oak wood/Acryl Eichenholz/Acryl	zintegrowane - integrated integriert 1xLED 24V 48 W, 4480 lm, 3000 K
	2	91402274	Tak/Yes/Ja			
	3	9141174	---			zintegrowane - integrated integriert 1xLED 24V 34 W, 3220 lm, 3000 K
	4	91401174	Tak/Yes/Ja			
	5	9145274	---			zintegrowane - integrated integriert 1xLED 24V 48 W, 4480 lm, 3000 K
	6	91405274	Tak/Yes/Ja			

Made in Europe, 5 Years Guarantee

Z zastrzeżeniem zmian i możliwych błędów/Subject to changes and possible errors/Irrtümer und Änderungen vorbehalten.

RAMME



Touch Dimmer

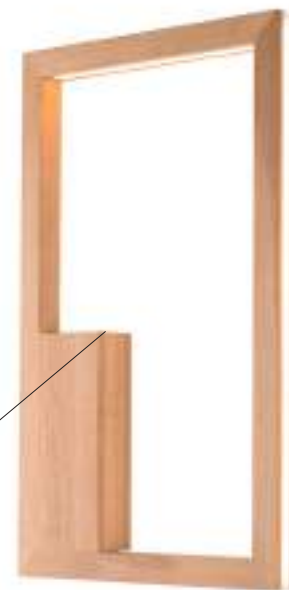

1) 9143174

Touch Dimmer

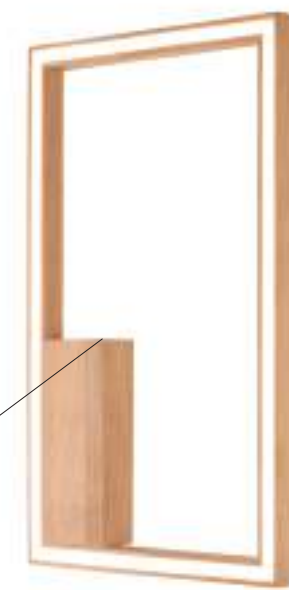

2) 9144174

Dostępne konfiguracje/Available configurations/Verfügbare Konfigurationen



RAMME

Wymiary Dimensions Maße	Lp. No. Lfd. Nr.	Nr art. Item No. Art.-Nr.	Strumień światła Stream of light Lichtstrom	Kolor drewna Wood color Holzarbe	Materiał Material Material	Źródło światła Light source Lichtquelle
	1	9143174	Do środka i na zewnątrz Inside & outside Nach Innen und Aussen	Dąb olejowany Oiled Oak Eiche geölt	Drewno dębowe/Akryl Oak wood/Acrylic Eichenholz/Acryl	zintegrowane - integrated integriert 1xLED 24V 28 W, 2590 lm, 3000 K with Touch Dimmer
	2	9144174	Na wprost Straight on Geradeaus			zintegrowane - integrated integriert 1xLED 24V 24 W, 2240 lm, 3000 K with Touch Dimmer

Made in Europe, 5 Years Guarantee

Z zastrzeżeniem zmian i możliwych błędów/Subject to changes and possible errors/Irrtümer und Änderungen vorbehalten.

24V LED

SPOT Light jest prekursorem stosowania technologii LED 24V w oprawach drewnianych. Charakteryzuje się ona wysokim współczynnikiem mocy, tzw. Power Factor świadczącym o wysokiej efektywności wykorzystania energii. Moduły LED 24V pobierają o połowę mniej prądu w porównaniu z systemem 12V, aby osiągnąć ten sam poziom mocy. Emitują przy tym znacznie mniej ciepła co sprawia, że żywotność opraw wyposażonych w LED 24V jest dłuższa. Do produkcji modułów używamy najlepszych dostępnych komponentów: diod firmy Samsung, taśm 3M, wysokiej jakości zasilaczy i ściemniaczy dotykowych renomowanych producentów. Wszystko to składa się na optymalny efekt oświetleniowy: silne, ciepłe i stabilne światło bez uciążliwego migotania. Moduły LED 24V zabudowane w naszych oprawach oświetleniowych charakteryzują się najwyższą jakością, którą potwierdzamy 5-letnią gwarancją.*

*Regulamin gwarancji dostępny na www.spotlight.pl

SPOT Light is a forerunner in the use of 24V LED technology in wooden luminaires. It is characterised by the high Power Factor, which is associated with high energy saving. 24V LED system draws half the amount of current as a 12V LED system to achieve the same power level. Moreover, the lower heat emission means, that the life span of the luminaires is longer. We use only the best components: Samsung LED Diodes, 3M tapes, high quality drivers and dimmers, that are coming from the most reputable manufacturers in the world. Together, these factors create an optimum lighting effect: strong, warm and stable light without flickering. Our 24V LED modules are characterized by the highest quality. We confirm this with our 5-year warranty.*

*The Guarantee Regulations can be found at www.spotlight.pl

SPOT Light ist der Vorreiter, wenn es um den Einsatz der 24V-LED-Technologie in Holzleuchten geht. Diese Technologie zeichnet sich durch einen hohen Leistungsfaktor aus, dem sogenannten Power Factor, der eine hohe Energieeffizienz beweist. Das 24V-LED-System benötigt die Hälfte des Stroms eines 12V-LED-Systems, um die gleiche Leistung zu erzielen. Darüber hinaus sorgt eine geringere Wärmeabgabe für eine längere Lebensdauer der Leuchten. Wir verwenden nur die besten Komponenten: Samsung LED-Dioden, 3M-Bänder, hochwertige Treiber und Dimmer, die von den weltführenden Herstellern stammen. Dies alles ergibt ein optimales Licht: helles, warmes und stabiles Licht ohne störendes Flackern. Unsere 24V-LED-Module zeichnen sich durch höchste Qualität aus. Das bestätigen wir Ihnen mit unserer 5-jährigen Garantie.*

*Die Garantiebestimmungen finden Sie unter www.spotlight.pl



24V



KAGO LED



1) 6151074

Przykładowa konfiguracja/Example configuration/Beispielkonfiguration



KAGO LED

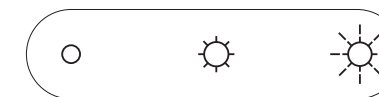
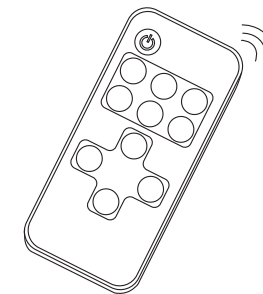

Ściemnianie pilotem
Dimming with remote control
Dimmen mit der Fernbedienung



Dostępne konfiguracje/Available configurations/Verfügbare Konfigurationen

KAGO LED

Wymiary Dimensions Maße	Lp. No. Lfd. Nr.	Nr art. Item No. Art.-Nr.	Pilot Remote control Fernbedienung	Kolor drewna Wood color Holzfarbe	Materiał Material Material	Źródło światła Light source Lichtquelle
	1	6151074	---	Dąb olejowany Oiled Oak Eiche geölt	Drewno dębowe/Akryl Oak wood/Acrylic Eichenholz/Acryl	zintegrowane - integrated integriert 1xLED 24V 21 W, 1960 lm, 3000 K
	2	61501074	Tak/Yes/Ja			
	3	6153074	---			zintegrowane - integrated integriert 1xLED 24V 36 W, 3360 lm, 3000 K
	4	61503074	Tak/Yes/Ja			
	5	6155074	---			zintegrowane - integrated integriert 1xLED 24V 43,5 W, 4060 lm, 3000 K
	6	61505074	Tak/Yes/Ja			
	7	9152174	---			zintegrowane - integrated integriert 1xLED 24V 9 W, 840 lm, 3000 K
	8	91502174	Tak/Yes/Ja			

Made in Europe, 5 Years Guarantee



Przykładowa konfiguracja/Example configuration/Beispielkonfiguration

Z zastrzeżeniem zmian i możliwych błędów/Subject to changes and possible errors/Irrtümer und Änderungen vorbehalten.

KAGO LED



1) 9153174



5) 9157174



3) 9156174

Przykładowa konfiguracja/Example configuration/Beispielkonfiguration

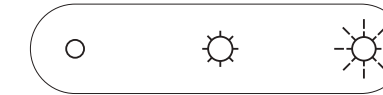
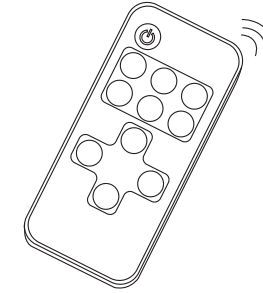

Ściemnianie pilotem
Dimming with remote control
Dimmen mit der Fernbedienung

Dostępne konfiguracje/Available configurations/Verfügbare Konfigurationen



KAGO LED

Wymiary Dimensions Maße	Lp. No. Lfd. Nr.	Nr art. Item No. Art.-Nr.	Pilot Remote control Fernbedienung	Kolor drewna Wood color Holzfarbe	Materiał Material Material	Źródło światła Light source Lichtquelle
	1	9153174	---	Dąb olejowany Oiled Oak Eiche geölt	Drewno dębowe/Akryl Oak wood/Acrylic Eichenholz/Acryl	zintegrowane - integrated integriert 1xLED 24V 9 W, 840 lm, 3000 K
	2	91503174	Tak/Yes/Ja			
	3	9156174	---			zintegrowane - integrated integriert 1xLED 24V 27 W, 2520 lm, 3000 K
	4	91506174	Tak/Yes/Ja			
	5	9157174	---			zintegrowane - integrated integriert 1xLED 24V 27 W, 2520 lm, 3000 K
	6	91507174	Tak/Yes/Ja			

Made in Europe, 5 Years Guarantee

Z zastrzeżeniem zmian i możliwych błędów/Subject to changes and possible errors/Irrtümer und Änderungen vorbehalten.

TAVOLI GLASS



TAVOLI



Przykładowa konfiguracja/Example configuration/Beispielkonfiguration



Maksymalne obciążenie
Max. load
Max. Belastung

Dostępne konfiguracje/Available configurations/Verfügbare Konfigurationen



TAVOLI / TAVOLI GLASS

Wymiary Dimensions Maße	Lp. No. Lfd. Nr.	Nr art. Item No. Art.-Nr.	Szkoło Glass Glas	Kolor drewna Wood color Holzfarbe	Materiał Material Material	Źródło światła Light source Lichtquelle
	1	8871974	---	Dąb olejowany Oiled Oak Eiche geölt	Drewno dębowe/Akryl Oak wood/Acrylic Eichenholz/Acryl	zintegrowane - integrated integriert 1xLED 24V 27 W, 2520 lm, 3000 K with Touch Dimmer
	2	8881974	Szronione Frosted Milchglas		Drewno dębowe/Szkoło/Akryl Oak wood/Glass/Acrylic Eichenholz/Glas/Acryl	
	3	8872974	---		Drewno dębowe/Akryl Oak wood/Acrylic Eichenholz/Acryl	zintegrowane - integrated integriert 1xLED 24V 33 W, 3080 lm, 3000 K with Touch Dimmer
	4	8882974	Szronione Frosted Milchglas		Drewno dębowe/Szkoło/Akryl Oak wood/Glass/Acrylic Eichenholz/Glas/Acryl	
	5	8873974	---		Drewno dębowe/Akryl Oak wood/Acrylic Eichenholz/Acryl	zintegrowane - integrated integriert 1xLED 24V 45 W, 4200 lm, 3000 K with Touch Dimmer
	6	8883974	Szronione Frosted Milchglas		Drewno dębowe/Szkoło/Akryl Oak wood/Glass/Acrylic Eichenholz/Glas/Acryl	

Made in Europe, 5 Years Guarantee

Nr szkła - Glass No. - Glas-Nr. G0492 (pos. 2), G0493 (pos. 4. 6.)

Z zastrzeżeniem zmian i możliwych błędów/Subject to changes and possible errors/Irrtümer und Änderungen vorbehalten.

KAGO





4) 61580474



1) 61540174

KAGO

Wymiary Dimensions Maße	Lp. No. Lfd. Nr.	Nr art. Item No. Art.-Nr.	Oprawka Light fitting Fassung	Kolor drewna Wood color Holzfarbe	Materiał Material Material	Źródło światła Light source Lichtquelle
	1	61540174	Czarny Black Schwarz	Dąb olejowany Oiled Oak Eiche geölt	Drewno dębowe/Metal Oak wood/Metal Eichenholz/Metall	1xE27 max. 60 W
	2	61580174	Chrom Chrome Chrom			
	3	61540474	Czarny Black Schwarz			4xE27 max. 60 W
	4	61580474	Chrom Chrome Chrom			
	5	61590474	Czarny Black Schwarz			4xE27 max. 60 W
	6	61500474	Chrom Chrome Chrom			

Made in Europe

KAGO



1) 9154174



2) 9158174



3) 9154274



4) 9158274

Przykładowa konfiguracja/Example configuration/Beispielkonfiguration



5) 9154374



6) 9158374



9) 9154474



10) 9158474

KAGO

Wymiary Dimensions Maße	Lp. No. Lfd. Nr.	Nr art. Item No. Art.-Nr.	Oprawka Light fitting Fassung	Kolor drewna Wood color Holzfarbe	Materiał Material Material	Źródło światła Light source Lichtquelle
	1	9154174	Czarny Black Schwarz	Dąb olejowany Oiled Oak Eiche geölt	Drewno dębowe/Metal Oak wood/Metal Eichenholz/Metall	1xE27 max. 60 W
	2	9158174	Chrom Chrome Chrom			
	3	9154274	Czarny Black Schwarz			2xE27 max. 60 W
	4	9158274	Chrom Chrome Chrom			
	5	9154374	Czarny Black Schwarz			3xE27 max. 60 W
	6	9158374	Chrom Chrome Chrom			
	7	9154474L	Czarny Black Schwarz			4xE27 max. 60 W
	8	9158474L	Chrom Chrome Chrom			
	9	9154474	Czarny Black Schwarz			4xE27 max. 60 W
	10	9158474	Chrom Chrome Chrom			

Made in Europe

KAGO



6) 51518274

Przykładowa konfiguracja/Example configuration/Beispielkonfiguration



5) 51524374

Przykładowa konfiguracja/Example configuration/Beispielkonfiguration



5) 51528374



2) 9150174



1) 9159174

Przykładowa konfiguracja/Example configuration/Beispielkonfiguration

Dostępne konfiguracje/Available configurations/Verfügbare Konfigurationen

KAGO

Wymiary Dimensions Maße	Lp. No. Lfd. Nr.	Nr art. Item No. Art.-Nr.	Oprawka Light fitting Fassung	Kolor drewna Wood color Holzfarbe	Materiał Material Material	Źródło światła Light source Lichtquelle
	1	9159174	Czarny Black Schwarz	Dąb olejowany Oiled Oak Eiche geölt	Drewno dębowe/Metal Oak wood/Metal Eichenholz/Metall	1xE27 max. 40 W
	2	9150174	Chrom Chrome Chrom			
	3	7154174	Czarny Black Schwarz			2xE27 max. 60 W
	4	7158174	Chrom Chrome Chrom			
	5	51514274	Czarny Black Schwarz			2xE27 max. 60 W
	6	51518274	Chrom Chrome Chrom			
	7	51524274	Czarny Black Schwarz			3xE27 max. 60 W
	8	51528274	Chrom Chrome Chrom			
	9	51524374	Czarny Black Schwarz			3xE27 max. 60 W
	10	51528374	Chrom Chrome Chrom			

Made in Europe

Z zastrzeżeniem zmian i możliwych błędów/Subject to changes and possible errors/Irtümer und Änderungen vorbehalten.

ROY



Przykładowa konfiguracja/Example configuration/Beispielkonfiguration



2) 61620474

1) 61640474



Dostępne konfiguracje/Available configurations/Verfügbare Konfigurationen

ROY

Wymiary Dimensions Maße	Lp. No. Lfd. Nr.	Nr art. Item No. Art.-Nr.	Kolor - Color - Farbe		Materiał Material Material	Źródło światła Light source Lichtquelle
			Spot - Head - Kopf	Drewno - Wood - Holz		
	1	61640474	Czarny - Black - Schwarz	Dąb olejowany Oiled Oak Eiche geölt	Drewno dębowe/Metal Oak wood/Metal Eichenholz/Metall	Incl. 4xLED GU10 5 W 320 lm, 2700 K, Ra>90
	2	61620474	Biały - White - Weiss			
	3	61670474	Satyna - Satin - Satin			

Made in Europe

Z zastrzeżeniem zmian i możliwych błędów/Subject to changes and possible errors/Irtümer und Änderungen vorbehalten.

ROY



3) 5227174



5) 5222274



2) 5222174



4) 5224274

Przykładowa konfiguracja/Example configuration/Beispielkonfiguration

ROY



Dostępne konfiguracje/Available configurations/Verfügbare Konfigurationen



7) 5224374



9) 5227374



14) 5222474L

Przykładowa konfiguracja/Example configuration/Beispielkonfiguration

ROY

Wymiary Dimensions Maße	Lp. No. Lfd. Nr.	Nr art. Item No. Art.-Nr.	Kolor - Color - Farbe		Materiał Material Material	Źródło światła Light source Lichtquelle
			Spot - Head - Kopf	Drewno - Wood - Holz		
	1	5224174	Czarny - Black - Schwarz	Dąb olejowany Oiled Oak Eiche geölt	Drewno dębowe/Metal Oak wood/Metal Eichenholz/Metall	Incl. 1xLED GU10 5 W 320 lm, 2700 K, Ra>90
	2	5222174	Biały - White - Weiss			
	3	5227174	Satyna - Satin - Satin			
	4	5224274	Czarny - Black - Schwarz			Incl. 2xLED GU10 5 W 320 lm, 2700 K, Ra>90
	5	5222274	Biały - White - Weiss			
	6	5227274	Satyna - Satin - Satin			
	7	5224374	Czarny - Black - Schwarz			Incl. 3xLED GU10 5 W 320 lm, 2700 K, Ra>90
	8	5222374	Biały - White - Weiss			
	9	5227374	Satyna - Satin - Satin			
	10	5224474	Czarny - Black - Schwarz			Incl. 4xLED GU10 5 W 320 lm, 2700 K, Ra>90
	11	5222474	Biały - White - Weiss			
	12	5227474	Satyna - Satin - Satin			
	13	5224474L	Czarny - Black - Schwarz			Incl. 4xLED GU10 5 W 320 lm, 2700 K, Ra>90
	14	5222474L	Biały - White - Weiss			
	15	5227474L	Satyna - Satin - Satin			

Made in Europe

Z zastrzeżeniem zmian i możliwych błędów/Subject to changes and possible errors/Irrtümer und Änderungen vorbehalten.

BALL WOOD



5) 5141374

Przykładowa konfiguracja/Example configuration/Beispielkonfiguration



1) 5141174

4) 5143176



8) 5143376

Przykładowa konfiguracja/Example configuration/Beispielkonfiguration

BALL WOOD



Dostępne konfiguracje/Available configurations/Verfügbare Konfigurationen



11) 5141376R



10) 5143374R

BALL WOOD						
Wymiary Dimensions Maße	Lp. No. Lfd. Nr.	Nr art. Item No. Art.-Nr.	Kolor - Color - Farbe		Materiał Material Material	Źródło światła Light source Lichtquelle
			Podsufitka - Canopy - Baldachin	Klosz - Head - Kopf		
	1	5141174	Dąb olejowany Oiled oak Eiche geölt	Satyna Satin	Drewno dębowe/Metal Oak wood/Metal Eichenholz/Metall	Incl. 1xLED GU10 5 W 320 lm, 2700 K, Ra>90
	2	5143174		Czarny Black Schwarz		
	3	5141176	Orzech Walnut Walnuss	Satyna Satin	Drewno bukowe/Metal Beech wood/Metal Buchenholz/Metall	
	4	5143176		Czarny Black Schwarz		
	5	5141374	Dąb olejowany Oiled oak Eiche geölt	Satyna Satin	Drewno dębowe/Metal Oak wood/Metal Eichenholz/Metall	Incl. 3xLED GU10 5 W 320 lm, 2700 K, Ra>90
	6	5143374		Czarny Black Schwarz		
	7	5141376	Orzech Walnut Walnuss	Satyna Satin	Drewno bukowe/Metal Beech wood/Metal Buchenholz/Metall	
	8	5143376		Czarny Black Schwarz		
	9	5141374R	Dąb olejowany Oiled oak Eiche geölt	Satyna Satin	Drewno dębowe/Metal Oak wood/Metal Eichenholz/Metall	Incl. 3xLED GU10 5 W 320 lm, 2700 K, Ra>90
	10	5143374R		Czarny Black Schwarz		
	11	5141376R	Orzech Walnut Walnuss	Satyna Satin	Drewno bukowe/Metal Beech wood/Metal Buchenholz/Metall	
	12	5143376R		Czarny Black Schwarz		

Made in Europe

Przykładowa konfiguracja/Example configuration/Beispielkonfiguration

Z zastrzeżeniem zmian i możliwych błędów/Subject to changes and possible errors/Irrtümer und Änderungen vorbehalten.

TRIGONON



2) 1271976

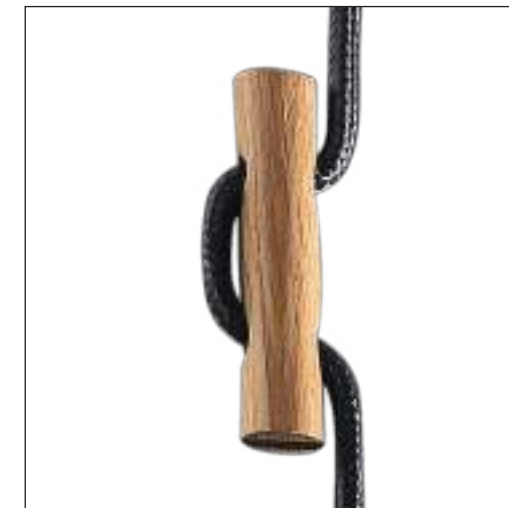

Dostępne konfiguracje/Available configurations/Verfügbare Konfigurationen



TRIGONON

Wymiary Dimensions Maße	Lp. No. Lfd. Nr.	Nr art. Item No. Art.-Nr.	Kolor drewna Wood color Holzfarbe	Materiał Material Material	Kolor kabla Cable Color Kabelfarbe	Oprawka Socket Fassung
	1	1271174	Dąb olejowany Oiled Oak Eiche geölt	Drewno dębowe Oak wood Eichenholz	Antracyt/W oplocie Dark grey/Braided Anthrazit/Geflochten	1xE27 max. 60 W
	2	1271976	Orzech Walnut Nussbaum	Drewno bukowe Beech wood Buchenholz	Czarny/W oplocie Black/Braided Schwarz/Geflochten	

Made in Europe

Z zastrzeżeniem zmian i możliwych błędów/Subject to changes and possible errors/Irrtümer und Änderungen vorbehalten.

Przykładowa konfiguracja/Example configuration/Beispielkonfiguration

CARSTEN WOOD



2) 1652174

Przykładowa konfiguracja/Example configuration/Beispielkonfiguration



Dostępne konfiguracje/Available configurations/Verfügbare Konfigurationen

CARSTEN WOOD

Wymiary Dimensions Maße	Lp. No. Lfd. Nr.	Nr art. Item No. Art.-Nr.	Kolor Color Farbe	Materiał Material Material	Oprawka Socket Fassung
	1	1650174			
	2	1652174	Czarny/Dąb olejowany Black/Oiled Oak Schwarz/Eiche geölt	Metal/Drewno dębowe Metal/Oak wood Metall/Eichenholz	1xE27 max. 60 W
	3	1651174			

Made in Europe

Z zastrzeżeniem zmian i możliwych błędów/Subject to changes and possible errors/Irrtümer und Änderungen vorbehalten.



E



C

Ludzie, żeby żyć potrzebują lasów - filtrują wodę, którą pijemy i powietrze, którym oddychamy. Bez respektowania zasad ochrony przyrody w gospodarce leśnej zachowanie tego niezwykłego dobra naturalnego dla przyszłych pokoleń nie będzie możliwe. SPOT Light jako jeden z nielicznych producentów oświetlenia w Europie posiada certyfikat FSC®. Oznacza to, że do produkcji naszych opraw drewnianych używamy drewna pochodzącego z lasów spełniających standardy dobrej praktyki drzewnej. Kupując nasze produkty z najwyższej jakości polskiego drewna dębowego, bukowego i brzozowego masz pewność, że zostały wykonane z surowców pochodzących z legalnego źródła i przyczyniasz się tym samym do ochrony ekosystemów leśnych.



People depend on forests to live. They filter the water we drink and the air we breathe. It is crucial, that we can meet our current needs for forest products without compromising the health of the world's forests for future generations. SPOT Light belongs to the very few lighting manufacturers in Europe that are FSC® certified. This trademark on our products provides a guarantee, that the wood we use for production is legally sourced and originates from sustainably managed forests. By purchasing our luminaires made from the highest quality Polish oak, beech and birch wood, you contribute to the protection of forest ecosystems.



O

Der Mensch braucht den Wald zum Überleben. Der Wald filtert das Wasser, das wir trinken, und die Luft, die wir atmen. Es ist entscheidend, den Bedarf an Holz so zu decken, dass der Bestand der Wälder dieser Erde für zukünftige Generationen bewahrt wird. SPOT Light gehört zu den wenigen Leuchtenherstellern in Europa, die FSC® zertifiziert sind. Dieses Siegel auf unseren Produkten bietet die Garantie, dass das Holz für unsere Produkte legal beschafft aus nachhaltig bewirtschafteten Wäldern stammt. Mit dem Kauf unserer Leuchten aus hochwertiger polnischer Eiche, Buche oder Birke Sie tragen zum Schutz von Waldökosystemen bei.

**TRABO
LONG**



3) 69214504



6) 69204304

Przykładowa konfiguracja/Example configuration/Beispielkonfiguration

TRABO LONG



1) 69314504



2) 69304504

Przykładowa konfiguracja/Example configuration/Beispielkonfiguration

Seria Trabo zawiera elementy drewniane. Drewno jest i pozostaje produktem naturalnym, dlatego też różnice w usłojeniu, wybarwieniu, odchylenia od podanych wymiarów, jak również chropowata powierzchnia, pęknięcia, sęki oraz zmiana koloru drewna pod wpływem kontaktu ze światłem słonecznym nie stanowią wady produktu i nie mogą stanowić podstawy reklamacji.

The Trabo series contains wooden elements. Wood is and remain a natural product, therefore variations in grain, color, deviations from the specified dimensions as well as rough surface, cracks, knots and changes in the wood color due to sun exposure are not a defect of the product and can not result in complaints.

Die Trabo-Serie enthält Holzelemente. Holz ist und bleibt ein Naturprodukt, daher sind Unterschiede in der Maserung, Färbung, Abweichungen von den angegebenen Maßen sowie raue Stellen, Trockenrisse, Äste und Veränderungen in der Holzfarbe durch Sonneneinstrahlung kein Mangel des Produkts und können keine Grundlage für Reklamationen sein.



Dostępne konfiguracje/Available configurations/Verfügbare Konfigurationen

TRABO LONG

Wymiary Dimensions Maße	Lp. No. Lfd. Nr.	Nr art. Item No. Art.-Nr.	Kolor Color Farbe	Materiał Material Material	Oprawka Socket Fassung
	1	69314504	Naturalna sosna/Czarny Natural pine/Black Kiefer Natur/Schwarz	Drewno sosnowe/Metal Pine wood/Metal Kiefernholz/Metall	5xE27 max. 60 W
	2	69304504	Sosna bejcowana/Czarny Stained Pine/Black Kiefer Gebeizt/Schwarz		
	3	69214504	Naturalna sosna/Czarny Natural pine/Black Kiefer Natur/Schwarz		5xE27 max. 60 W
	4	69204504	Sosna bejcowana/Czarny Stained Pine/Black Kiefer Gebeizt/Schwarz		
	5	69214304	Naturalna sosna/Czarny Natural pine/Black Kiefer Natur/Schwarz		3xE27 max. 60 W
	6	69204304	Sosna bejcowana/Czarny Stained Pine/Black Kiefer Gebeizt/Schwarz		

Made in Europe

Nr abażura - Shade No. - Schirm-Nr. P1027 (pos. 3-6)

Z zastrzeżeniem zmian i możliwych błędów/Subject to changes and possible errors/Irrtümer und Änderungen vorbehalten.

TRABO
SHORT



1) 68314304



2) 68304304



3) 68214304



4) 68204304

Przykładowa konfiguracja/Example configuration/Beispielkonfiguration

TRABO SHORT



6) 6834151



5) 6834150

Dostępne konfiguracje/Available configurations/Verfügbare Konfigurationen



TRABO SHORT

Wymiary Dimensions Maße	Lp. No. Lfd. Nr.	Nr art. Item No. Art.-Nr.	Kolor Color Farbe	Materiał Material Material	Oprawka Socket Fassung	
	1	68314304	Naturalna sosna/Czarny Natural pine/Black Kiefer Natur/Schwarz	Drewno sosnowe/Metal Pine wood/Metal Kiefernholz/Metall	3xE27 max. 60 W	
	2	68304304	Sosna bejcowana/Czarny Stained Pine/Black Kiefer Gebeizt/Schwarz			
	3	68214304	Naturalna sosna/Czarny Natural pine/Black Kiefer Natur/Schwarz			
	4	68204304	Sosna bejcowana/Czarny Stained Pine/Black Kiefer Gebeizt/Schwarz			
	5	6834150	Naturalna sosna/Czarny Natural pine/Black Kiefer Natur/Schwarz			1xE27 max. 25 W
	6	6834151	Sosna bejcowana/Czarny Stained Pine/Black Kiefer Gebeizt/Schwarz			

Made in Europe

Nr abażura - Shade No. - Schirm-Nr. P1027 (pos. 3-4)

Przykładowa konfiguracja/Example configuration/Beispielkonfiguration

Z zastrzeżeniem zmian i możliwych błędów/Subject to changes and possible errors/Irrtümer und Änderungen vorbehalten.

TRABO PINO



1) 68315350



2) 68315351

Przykładowa konfiguracja/Example configuration/Beispielkonfiguration

TRABO PINO



5) 69369150



6) 69379151



3) 69315550

Przykładowa konfiguracja/Example configuration/Beispielkonfiguration



Dostępne konfiguracje/Available configurations/Verfügbare Konfigurationen

TRABO PINO

Wymiary Dimensions Maße	Lp. No. Lfd. Nr.	Nr art. Item No. Art.-Nr.	Kolor Color Farbe	Materiał Material Material	Oprawka Socket Fassung
	1	68315350	Naturalna sosna/Czarny Natural pine/Black Kiefer Natur/Schwarz	Drewno sosnowe/Metal Pine wood/Metal Kiefernholz/Metall	3xE27 max. 60 W
	2	68315351	Sosna bejcowana/Czarny Stained Pine/Black Kiefer Gebeizt/Schwarz		
	3	69315550	Naturalna sosna/Czarny Natural pine/Black Kiefer Natur/Schwarz	Drewno sosnowe Pine wood Kiefernholz	5xE27 max. 60 W
	4	69315551	Sosna bejcowana/Czarny Stained Pine/Black Kiefer Gebeizt/Schwarz		
	5	69369150	Naturalna sosna Natural pine Kiefer Natur	Drewno sosnowe Pine wood Kiefernholz	1xE27 max. 25 W
	6	69379151	Sosna bejcowana Stained Pine Kiefer Gebeizt		

Made in Europe

Z zastrzeżeniem zmian i możliwych błędów/Subject to changes and possible errors/Irrtümer und Änderungen vorbehalten.

TRABO CONCRETE



1) 68499304



2) 68599304

Przykładowa konfiguracja/Example configuration/Beispielkonfiguration

TRABO CONCRETE



4) 69599504



5) 69399150

Przykładowa konfiguracja/Example configuration/Beispielkonfiguration



Dostępne konfiguracje/Available configurations/Verfügbare Konfigurationen

TRABO CONCRETE

Wymiary Dimensions Maße	Lp. No. Lfd. Nr.	Nr art. Item No. Art.-Nr.	Kolor Color Farbe	Materiał Material Material	Oprawka Socket Fassung
	1	68499304	Naturalna sosna/Czarny/Szary Natural pine/Black/Grey Kiefer Natur/Schwarz/Grau	Drewno sosnowe/Metal/Beton Pine wood/Metal/Concrete Kiefernholz/Metall/Beton	3xE27 max. 60 W
	2	68599304	Sosna bejcowana/Czarny/Szary Stained Pine/Black/Grey Kiefer Gebeizt/Schwarz/Grau		
	3	69499504	Naturalna sosna/Czarny/Szary Natural pine/Black/Grey Kiefer Natur/Schwarz/Grau	Drewno sosnowe/Beton Pine wood/Concrete Kiefernholz/Beton	5xE27 max. 60 W
	4	69599504	Sosna bejcowana/Czarny/Szary Stained Pine/Black/Grey Kiefer Gebeizt/Schwarz/Grau		
	5	69399150	Naturalna sosna/Szary Natural pine/Grey Kiefer Natur/Grau	Drewno sosnowe/Beton Pine wood/Concrete Kiefernholz/Beton	1xE27 max. 25 W
	6	69399151	Sosna bejcowana/Szary Stained Pine/Grey Kiefer Gebeizt/Grau		

Made in Europe

Z zastrzeżeniem zmian i możliwych błędów/Subject to changes and possible errors/Irrtümer und Änderungen vorbehalten.

TRABO SIMPLE



1) 69860404



3) 69860604



2) 69880404



4) 69880604

Przykładowa konfiguracja/Example configuration/Beispielkonfiguration

TRABO SIMPLE



Dostępne konfiguracje/Available configurations/Verfügbare Konfigurationen



7) 6994150



5) 6996404



8) 6994153



6) 6998404

TRABO SIMPLE						
Wymiary Dimensions Maße	Lp. No. Lfd. Nr.	Nr art. Item No. Art.-Nr.	Kolor Color Farbe	Materiał Material Material	Oprawka Socket Fassung	
	1	69860404	Naturalna sosna/Czarny Natural pine/Black Kiefer Natur/Schwarz	Drewno sosnowe/Metal Pine wood/Metal Kiefernholz/Metall	4xE27 max. 60 W	
	2	69880404	Sosna bejcowana/Czarny Stained Pine/Black Kiefer Gebeizt/Schwarz			
	3	69860604	Naturalna sosna/Czarny Natural pine/Black Kiefer Natur/Schwarz		6xE27 max. 60 W	
	4	69880604	Sosna bejcowana/Czarny Stained Pine/Black Kiefer Gebeizt/Schwarz			
	5	6996404	Naturalna sosna/Czarny Natural pine/Black Kiefer Natur/Schwarz		4xE27 max. 60 W	
	6	6998404	Sosna bejcowana/Czarny Stained Pine/Black Kiefer Gebeizt/Schwarz			
	7	6994150	Naturalna sosna Natural pine Kiefer Natur		Drewno sosnowe Pine wood Kiefernholz	1xE27 max. 25 W
	8	6994151	Sosna bejcowana Stained Pine Kiefer Gebeizt			

Made in Europe

Przykładowa konfiguracja/Example configuration/Beispielkonfiguration

Z zastrzeżeniem zmian i możliwych błędów/Subject to changes and possible errors/Irrtümer und Änderungen vorbehalten.

TRABO TABLE



Przykładowa konfiguracja/Example configuration/Beispielkonfiguration



1) 76911150



3) 76910150

Dostępne konfiguracje/Available configurations/Verfügbare Konfigurationen



TRABO TABLE

Wymiary Dimensions Maße	Lp. No. Lfd. Nr.	Nr art. Item No. Art.-Nr.	Kolor Color Farbe	Materiał Material Material	Oprawka Socket Fassung
	1	76911150	Naturalna sosna Natural pine Kiefer Natur	Drewno sosnowe Pine wood Kiefernholz	1xE27 max. 25 W
	2	76911151	Sosna bejcowana Stained Pine Kiefer Gebeizt		
	3	76910150	Naturalna sosna Natural pine Kiefer Natur		
	4	76910151	Sosna bejcowana Stained Pine Kiefer Gebeizt		

Made in Europe

Z zastrzeżeniem zmian i możliwych błędów/Subject to changes and possible errors/Irrtümer und Änderungen vorbehalten.

LUCAS



4) 69680104



3) 69660104

Przykładowa konfiguracja/Example configuration/Beispielkonfiguration

LUCAS



2) 69480104



1) 69460104

Przykładowa konfiguracja/Example configuration/Beispielkonfiguration

Seria Lucas zawiera elementy drewniane. Drewno jest i pozostaje produktem naturalnym, dlatego też różnice w usłojeniu, wybarwieniu, odchylenia od podanych wymiarów, jak również chropowata powierzchnia, pęknięcia, sęki oraz zmiana koloru drewna pod wpływem kontaktu ze światłem słonecznym nie stanowią wady produktu i nie mogą stanowić podstawy reklamacji.

The Lucas series contains wooden elements. Wood is and remain a natural product, therefore variations in grain, color, deviations from the specified dimensions as well as rough surface, cracks, knots and changes in the wood color due to sun exposure are not a defect of the product and can not result in complaints.

Die Lucas-Serie enthält Holzelemente. Holz ist und bleibt ein Naturprodukt, daher sind Unterschiede in der Maserung, Färbung, Abweichungen von den angegebenen Maßen sowie raue Stellen, Trockenrisse, Äste und Veränderungen in der Holzfarbe durch Sonneneinstrahlung kein Mangel des Produkts und können keine Grundlage für Reklamationen sein.



Dostępne konfiguracje/Available configurations/Verfügbare Konfigurationen

LUCAS

Wymiary Dimensions Maße	Lp. No. Lfd. Nr.	Nr art. Item No. Art.-Nr.	Kolor Color Farbe	Materiał Material Material	Źródło światła Light source Lichtquelle
	1	69460104	Naturalna sosna/Czarny Natural pine/Black Kiefer Natur/Schwarz	Drewno sosnowe/Metal/Akryl Pine wood/Metal/Acrylic Kiefernholz/Metall/Acryl	zintegrowane - integrated integriert 1xLED 24V 25,5 W, 2380 lm, 3000 K with Touch Dimmer
	2	69480104	Sosna bejcowana/Czarny Stained Pine/Black Kiefer Gebeizt/Schwarz		
	3	69660104	Naturalna sosna/Czarny Natural pine/Black Kiefer Natur/Schwarz		zintegrowane - integrated integriert 1xLED 24V 33 W, 3080 lm, 3000 K with Touch Dimmer
	4	69680104	Sosna bejcowana/Czarny Stained Pine/Black Kiefer Gebeizt/Schwarz		

Made in Europe, 5 Years Guarantee

Z zastrzeżeniem zmian i możliwych błędów/Subject to changes and possible errors/Irrtümer und Änderungen vorbehalten.

PINO FLOOR



2) 87627904

Przykładowa konfiguracja/Example configuration/Beispielkonfiguration

Seria Pino zawiera elementy drewniane. Drewno jest i pozostaje produktem naturalnym, dlatego też różnice w usłojeniu, wybarwieniu, odchylenia od podanych wymiarów, jak również chropowata powierzchnia, pęknięcia, sęki oraz zmiana koloru drewna pod wpływem kontaktu ze światłem słonecznym nie stanowią wady produktu i nie mogą stanowić podstawy reklamacji.

The Pino series contains wooden elements. Wood is and remain a natural product, therefore variations in grain, color, deviations from the specified dimensions as well as rough surface, cracks, knots and changes in the wood color due to sun exposure are not a defect of the product and can not result in complaints.

Die Pino-Serie enthält Holzelemente. Holz ist und bleibt ein Naturprodukt, daher sind Unterschiede in der Maserung, Färbung, Abweichungen von den angegebenen Maßen sowie raue Stellen, Trockenrisse, Äste und Veränderungen in der Holzfarbe durch Sonneneinstrahlung kein Mangel des Produkts und können keine Grundlage für Reklamationen sein.



Dostępne konfiguracje/Available configurations/Verfügbare Konfigurationen

PINO FLOOR

Wymiary Dimensions Maße	Lp. No. Lfd. Nr.	Nr art. Item No. Art.-Nr.	Kolor - Color - Farbe		Materiał Material Material	Kabel Cable Kabel	Oprawka Socket Fassung
			Podstawa - Base - Fuss	Abażur - Shade - Schirm			
	1	87626904	Naturalna sosna/Czarny Natural pine/Black Kiefer Natur/Schwarz	Biały White Weiss	Drewno sosnowe/Metal/Tkanina Pine wood/Metal/Fabric Kiefernholz/Metall/Stoff	Czarny/W oplocie Black/Braided Schwarz/Geflochten	1xE27 max. 60 W
	2	87627904	Sosna bejcowana/Czarny Stained Pine/Black Kiefer Gebeizt/Schwarz				

Made in Europe

Nr abażura - Shade No. - Schirm-Nr. A0510

Z zastrzeżeniem zmian i możliwych błędów/Subject to changes and possible errors/Irtümer und Änderungen vorbehalten.

PINO TABLE



1) 77626904

Przykładowa konfiguracja/Example configuration/Beispielkonfiguration



Dostępne konfiguracje/Available configurations/Verfügbare Konfigurationen



PINO TABLE

Wymiary Dimensions Maße	Lp. No. Lfd. Nr.	Nr art. Item No. Art.-Nr.	Kolor - Color - Farbe		Materiał Material Material	Kabel Cable Kabel	Oprawka Socket Fassung
			Podstawa - Base - Fuss	Abażur - Shade - Schirm			
	1	77626904	Naturalna sosna/Czarny Natural pine/Black Kiefer Natur/Schwarz	Biały White Weiss	Drewno sosnowe/Metal/Tkanina Pine wood/Metal/Fabric Kiefernholz/Metall/Stoff	Czarny/W oplocie Black/Braided Schwarz/Geflochten	1xE27 max. 40 W
	2	77627904	Sosna bejcowana/Czarny Stained Pine/Black Kiefer Gebeizt/Schwarz				

Made in Europe

Nr abażura - Shade No. - Schirm-Nr. A0514

Z zastrzeżeniem zmian i możliwych błędów/Subject to changes and possible errors/Irrtümer und Änderungen vorbehalten.

PINO



1) 7161150



5) 7161350



3) 7161350R

Przykładowa konfiguracja/Example configuration/Beispielkonfiguration

PINO



Dostępne konfiguracje/Available configurations/Verfügbare Konfigurationen



2) 71689104



6) 71689304



4) 71689304R

PINO					
Wymiary Dimensions Maße	Lp. No. Lfd. Nr.	Nr art. Item No. Art.-Nr.	Kolor Color Farbe	Materiał Material Material	Oprawka Socket Fassung
	1	7161150	Naturalna sosna/Czarny Natural pine/Black Kiefer Natur/Schwarz	Drewno sosnowe/Metal Pine wood/Metal Kiefernholz/Metall	1xE27 max. 60 W
	2	71689104	Sosna bejcowana/Czarny Stained Pine/Black Kiefer Gebeizt/Schwarz		
	3	7161350R	Naturalna sosna/Czarny Natural pine/Black Kiefer Natur/Schwarz		3xE27 max. 60 W
	4	71689304R	Sosna bejcowana/Czarny Stained Pine/Black Kiefer Gebeizt/Schwarz		
	5	7161350	Naturalna sosna/Czarny Natural pine/Black Kiefer Natur/Schwarz		3xE27 max. 60 W
	6	71689304	Sosna bejcowana/Czarny Stained Pine/Black Kiefer Gebeizt/Schwarz		

Made in Europe

Z zastrzeżeniem zmian i możliwych błędów/Subject to changes and possible errors/Irrtümer und Änderungen vorbehalten.

Przykładowa konfiguracja/Example configuration/Beispielkonfiguration

TRONGO ROUND



5) 7061374R

Przykładowa konfiguracja/Example configuration/Beispielkonfiguration



2) 7069176

Przykładowa konfiguracja/Example configuration/Beispielkonfiguration



6) 7069376R

TRONGO ROUND



Dostępne konfiguracje/Available configurations/Verfügbare Konfigurationen



3) 7061374L



4) 7069376L

TRONGO Round						
Wymiary Dimensions Maße	Lp. No. Lfd. Nr.	Nr art. Item No. Art.-Nr.	Kolor drewna Wood color Holzfarbe	Materiał Material Material	Kolor kabla Cable Color Kabelfarbe	Oprawka Socket Fassung
	1	7061174	Dąb olejowany Oiled Oak Eiche geölt	Drewno dębowe Oak wood Eichenholz	Antracyt/W oplocie Dark grey/Braided Anthrazit/Geflochten	1xE27 max. 60 W
	2	7069176	Orzech Walnut Nussbaum	Drewno bukowe Beech wood Buchenholz	Czarny/W oplocie Black/Braided Schwarz/Geflochten	
	3	7061374L	Dąb olejowany Oiled Oak Eiche geölt	Drewno dębowe Oak wood Eichenholz	Antracyt/W oplocie Dark grey/Braided Anthrazit/Geflochten	3xE27 max. 60 W
	4	7069376L	Orzech Walnut Nussbaum	Drewno bukowe Beech wood Buchenholz	Czarny/W oplocie Black/Braided Schwarz/Geflochten	
	5	7061374R	Dąb olejowany Oiled Oak Eiche geölt	Drewno dębowe Oak wood Eichenholz	Antracyt/W oplocie Dark grey/Braided Anthrazit/Geflochten	3xE27 max. 60 W
	6	7069376R	Orzech Walnut Nussbaum	Drewno bukowe Beech wood Buchenholz	Czarny/W oplocie Black/Braided Schwarz/Geflochten	

Made in Europe

Z zastrzeżeniem zmian i możliwych błędów/Subject to changes and possible errors/Irtümer und Änderungen vorbehalten.

Przykładowa konfiguracja/Example configuration/Beispielkonfiguration

TRONGO SQUARE



1) 7161174

Przykładowa konfiguracja/Example configuration/Beispielkonfiguration



3) 7161374L

Przykładowa konfiguracja/Example configuration/Beispielkonfiguration



4) 7169376L

TRONGO SQUARE



Dostępne konfiguracje/Available configurations/Verfügbare Konfigurationen

TRONGO Square



5) 7161474



6) 7169476

Przykładowa konfiguracja/Example configuration/Beispielkonfiguration

Wymiary Dimensions Maße	Lp. No. Lfd. Nr.	Nr art. Item No. Art.-Nr.	Kolor drewna Wood color Holzfarbe	Materiał Material Material	Kolor kabla Cable Color Kabelfarbe	Oprawka Socket Fassung
	1	7161174	Dąb olejowany Oiled Oak Eiche geölt	Drewno dębowe Oak wood Eichenholz	Antracyt/W oplocie Dark grey/Braided Anthrazit/Geflochten	1xE27 max. 60 W
	2	7169176	Orzech Walnut Nussbaum	Drewno bukowe Beech wood Buchenholz	Czarny/W oplocie Black/Braided Schwarz/Geflochten	
	3	7161374L	Dąb olejowany Oiled Oak Eiche geölt	Drewno dębowe Oak wood Eichenholz	Antracyt/W oplocie Dark grey/Braided Anthrazit/Geflochten	3xE27 max. 60 W
	4	7169376L	Orzech Walnut Nussbaum	Drewno bukowe Beech wood Buchenholz	Czarny/W oplocie Black/Braided Schwarz/Geflochten	
	5	7161474	Dąb olejowany Oiled Oak Eiche geölt	Drewno dębowe Oak wood Eichenholz	Antracyt/W oplocie Dark grey/Braided Anthrazit/Geflochten	4xE27 max. 60 W
	6	7169476	Orzech Walnut Nussbaum	Drewno bukowe Beech wood Buchenholz	Czarny/W oplocie Black/Braided Schwarz/Geflochten	

Made in Europe

Z zastrzeżeniem zmian i możliwych błędów/Subject to changes and possible errors/Irtümer und Änderungen vorbehalten.

ALESSANDRO



7) 1760374R



5) 1760376



6) 1760328

Przykładowa konfiguracja/Example configuration/Beispielkonfiguration

ALESSANDRO



3) 1760128

Przykładowa konfiguracja/Example configuration/Beispielkonfiguration



Dostępne konfiguracje/Available configurations/Verfügbare Konfigurationen

ALESSANDRO

Wymiary Dimensions Maße	Lp. No. Lfd. Nr.	Nr art. Item No. Art.-Nr.	Kolor - Color - Farbe			Materiał Material Material	Oprawka Socket Fassung			
			Podsufitka - Canopy - Baldachin	Szkoło - Glass - Glas	Kabel - Cable - Kabel					
	1	1760174	Dąb olejowany Oiled oak Eiche geölt	Transparentny Transparent Transparent	Transparentny Transparent Transparent	Drewno dębowe/Szkoło Oak wood/Glass Eichenholz/Glas	1xE27 max. 60 W			
	2	1760176	Orzech Walnut Walnuss							
	3	1760128	Chrom Chrome Chrom							
	4	1760374	Dąb olejowany Oiled oak Eiche geölt							
	5	1760376	Orzech Walnut Walnuss							
	6	1760328	Chrom Chrome Chrom							
	7	1760374R	Dąb olejowany Oiled oak Eiche geölt			Transparentny Transparent Transparent		Transparentny Transparent Transparent	Drewno dębowe/Szkoło Oak wood/Glass Eichenholz/Glas	3xE27 max. 60 W
	8	1760376R	Orzech Walnut Walnuss							
	9	1760338	Chrom Chrome Chrom							

Made in Europe

Nr szkła - Glass No. - Glas-Nr. G0867

Z zastrzeżeniem zmian i możliwych błędów/Subject to changes and possible errors/Irtümer und Änderungen vorbehalten.

LINEA



1) 1860174

Przykładowa konfiguracja/Example configuration/Beispielkonfiguration



LINEA



2) 1860176



4) 1860376R

Przykładowa konfiguracja/Example configuration/Beispielkonfiguration



Dostępne konfiguracje/Available configurations/Verfügbare Konfigurationen

LINEA

Wymiary Dimensions Maße	Lp. No. Lfd. Nr.	Nr art. Item No. Art.-Nr.	Kolor - Color - Farbe			Materiał Material Material	Oprawka Socket Fassung
			Podsufitka - Canopy - Baldachin	Szkoło - Glass - Glas	Kabel - Cable - Kabel		
	1	1860174	Dąb olejowany Oiled oak Eiche geölt	Szroniony-Transparentny Frosted-Transparent Milchglas-Transparent	Transparentny Transparent Transparent	Drewno dębowe/Szkoło Oak wood/Glass Eichenholz/Glas	1xE27 max. 60 W
	2	1860176	Orzech Walnut Walnuss				
	3	1860374R	Dąb olejowany Oiled oak Eiche geölt			Drewno dębowe/Szkoło Oak wood/Glass Eichenholz/Glas	3xE27 max. 60 W
	4	1860376R	Orzech Walnut Walnuss			Drewno bukowe/Szkoło Beech wood/Glass Buchenholz/Glas	

Made in Europe

Nr szkła - Glass No. - Glas-Nr. G1545

Z zastrzeżeniem zmian i możliwych błędów/Subject to changes and possible errors/Irrtümer und Änderungen vorbehalten.

AURA



2) 1450176



3) 1450374

Przykładowa konfiguracja/Example configuration/Beispielkonfiguration



Dostępne konfiguracje/Available configurations/Verfügbare Konfigurationen

AURA

Wymiary Dimensions Maße	Lp. No. Lfd. Nr.	Nr art. Item No. Art.-Nr.	Kolor - Color - Farbe			Materiał Material Material	Oprawka Socket Fassung
			Podsufitka - Canopy - Baldachin	Szkoło - Glass - Glas	Kabel - Cable - Kabel		
	1	1450174	Dąb olejowany Oiled oak Eiche geölt	Transparentny Transparent Transparent	Transparentny Transparent Transparent	Drewno dębowe/Szkoło Oak wood/Glass Eichenholz/Glas	1xE27 max. 60 W
	2	1450176	Orzech Walnut Walnuss			Drewno bukowe/Szkoło Beech wood/Glass Buchenholz/Glas	
	3	1450374	Dąb olejowany Oiled oak Eiche geölt			Drewno dębowe/Szkoło Oak wood/Glass Eichenholz/Glas	3xE27 max. 60 W
	4	1450376	Orzech Walnut Walnuss			Drewno bukowe/Szkoło Beech wood/Glass Buchenholz/Glas	

Made in Europe

Nr szkła - Glass No. - Glas-Nr. G0833

Z zastrzeżeniem zmian i możliwych błędów/Subject to changes and possible errors/Irtümer und Änderungen vorbehalten.

SVEA



3) 13560160



1) 13560174



2) 13560176

Dostępne konfiguracje/Available configurations/Verfügbare Konfigurationen



SVEA

Wymiary Dimensions Maße	Lp. No. Lfd. Nr.	Nr art. Item No. Art.-Nr.	Kolor - Color - Farbe			Materiał Material Material	Oprawka Socket Fassung
			Podsufitka - Canopy - Baldachin	Szkoło - Glass - Glas	Kabel - Cable - Kabel		
	1	13560174	Dąb olejowany Oiled oak Eiche geölt	Transparentny Transparent Transparent	Transparentny Transparent Transparent	Drewno dębowe/Szkoło Oak wood/Glass Eichenholz/Glas	1xE27 max. 60 W
	2	13560176	Orzech Walnut Walnuss			Drewno bukowe/Szkoło Beech wood/Glass Buchenholz/Glas	
	3	13560160	Brzoza Birch Birke			Drewno brzozowe/Szkoło Birch wood/Glass Birkenholz/Glas	

Made in Europe

Nr szkła - Glass No. - Glas-Nr. G0901

Z zastrzeżeniem zmian i możliwych błędów/Subject to changes and possible errors/Irrtümer und Änderungen vorbehalten.

OAK

Od ponad 20 lat SPOT Light tworzy wyjątkowe oprawy oświetleniowe z najpiękniejszego i najszlachetniejszego gatunku drewna europejskiej strefy klimatycznej jakim jest dąb. Dorasta on nawet do 40 metrów wysokości i może żyć nawet ponad 1000 lat. Dębina charakteryzuje się wyjątkową twardością, trwałością oraz pięknym usłojeniem. Dębowe elementy, których używamy do produkcji opraw oświetleniowych, są ręcznie olejowane, dzięki czemu zachowują naturalny wygląd i charakter. Ekologiczny olej wnika w głąb drewna, nie zatykając porów. Niezwykłą twardością charakteryzuje się również drewno bukowe, które obecnie bejcujemy na kolor orzecha amerykańskiego, zachowując przy tym widoczną naturalną strukturę drewna. Natomiast brzozę z jej delikatnym usłojeniem i jedwabistym połyskiem zabezpieczamy ekologicznym lakierem. Do produkcji naszych opraw oświetleniowych używamy wyłącznie starannie wyselekcjonowanego drewna z certyfikatem FSC®.

For over 20 years, SPOT Light has been creating unique luminaires from oak wood - the most beautiful and noble wood species of European climate zone. Oak grows up to 40 meters high and can live up to 1000 years. Oak wood is characterized by its strength, durability and beautiful graining. The oak elements, that we use for lighting production, are oiled by hand. Our ecological oils protect wood and bring out its natural beauty without clogging the pores. Another hardwood we work with is beech wood. We stain it nowadays to the color of American Walnut maintaining its visible, natural structure, while birch wood with its delicate grain and silky shine gets a varnish finish. For the production of our lighting fixtures we use only carefully selected FSC® certified wood.

Seit über 20 Jahren produziert SPOT Light einzigartige Leuchten aus Eichenholz - der schönsten und edelsten Holzart der europäischen Klimazone. Eiche wird bis zu 40 Meter hoch und kann bis zu 1000 Jahre alt werden. Eichenholz zeichnet sich durch seine Festigkeit, Langlebigkeit und schöne Maserung aus. Die Eichenelemente, die wir für die Leuchtenproduktion verwenden, wurden von Hand geölt. Unsere ökologischen Öle schützen das Holz und bringen seine natürliche Schönheit zur Geltung, ohne die Poren zu verstopfen. Ein weiteres Hartholz mit dem wir arbeiten ist Buchenholz, das bei uns in modernen Nussbaumton gebeizt wird. Es behält dabei seine natürliche Struktur bei. Das Birkenholz dagegen wird mit klarem Lack geschützt, der seine feine Maserung und den seidigen Glanz betont. Für die Herstellung unserer Leuchten verwenden wir nur sorgfältig ausgewähltes FSC®-zertifiziertes Holz.



BOSCO



1) 1720128



10) 1720574



4) 1720160



11) 1720576



BOSCO

8) 1720360



6) 1720374



13) 1720428



15) 1720476



Przykładowa konfiguracja/Example configuration/Beispielkonfiguration

BOSCO

Wymiary Dimensions Maße	Lp. No. Lfd. Nr.	Nr art. Item No. Art.-Nr.	Kolor - Color - Farbe			Materiał Material Material	Oprawka Socket Fassung
			Podsufitka - Canopy - Baldachin	Szkoło - Glass - Glas	Kabel - Cable - Kabel		
	1	1720128	Chrom Chrome Chrom	Biały White Weiss	Transparentny Transparent Transparent	Metal/Szkoło Metal/Glass Metall/Glas	1xE27 max. 60W
	2	1720174	Dąb olejowany Oiled oak Eiche geölt				
	3	1720176	Orzech Walnut Walnuss				
	4	1720160	Brzoza Birch Birke				
	5	1720328	Chrom Chrome Chrom	Biały White Weiss	Transparentny Transparent Transparent	Metal/Szkoło Metal/Glass Metall/Glas	3xE27 max. 60W
	6	1720374	Dąb olejowany Oiled oak Eiche geölt				
	7	1720376	Orzech Walnut Walnuss				
	8	1720360	Brzoza Birch Birke				
	9	1720328R	Chrom Chrome Chrom	Biały White Weiss	Transparentny Transparent Transparent	Metal/Szkoło Metal/Glass Metall/Glas	3xE27 max. 60W
	10	1720574	Dąb olejowany Oiled oak Eiche geölt				
	11	1720576	Orzech Walnut Walnuss				
	12	1720560	Brzoza Birch Birke				
	13	1720428	Chrom Chrome Chrom	Biały White Weiss	Transparentny Transparent Transparent	Metal/Szkoło Metal/Glass Metall/Glas	4xE27 max. 60W
	14	1720474	Dąb olejowany Oiled oak Eiche geölt				
	15	1720476	Orzech Walnut Walnuss				
	16	1720460	Brzoza Birch Birke				

Made in Europe

Nr szkła - Glass No. - Glas-Nr. G0770

Z zastrzeżeniem zmian i możliwych błędów/Subject to changes and possible errors/Irrtümer und Änderungen vorbehalten.

JONA



3) 1408976



4) 1408060



2) 1408032

Dostępne konfiguracje/Available configurations/Verfügbare Konfigurationen



JONA

Wymiary Dimensions Maße	Lp. No. Lfd. Nr.	Nr art. Item No. Art.-Nr.	Kolor - Color - Farbe			Materiał Material Material	Oprawka Socket Fassung
			Podsufitka - Canopy - Baldachin	Kabel - Cable - Kabel	Szkło - Glass - Glas		
	1	1408174	Dąb olejowany Oiled oak Eiche geölt	Antracyt/W oplocie Dark grey/Braided Anthrazit/Geflochten	Biały White Weiss	Drewno dębowe/Szkło Oak wood/Glass Eichenholz/Glas	1xE27 max. 60 W
	2	1408032	Dąb bielony Oak white Eiche Weiss	Transparentny Transparent Transparent			
	3	1408976	Orzech Walnut Walnuss	Czarny/W oplocie Black/Braided Schwarz/Geflochten			
	4	1408060	Brzoza Birch Birke	Transparentny Transparent Transparent			

Made in Europe

Nr szkła - Glass No. - Glas-Nr. G0635

Przykładowa konfiguracja/Example configuration/Beispielkonfiguration

Z zastrzeżeniem zmian i możliwych błędów/Subject to changes and possible errors/Irrtümer und Änderungen vorbehalten.

JENTA



1) 8512174



2) 8512176



9) 7522174



10) 7522176



3) 8512274



4) 8512276

Przykładowa konfiguracja/Example configuration/Beispielkonfiguration

JENTA



Dostępne konfiguracje/Available configurations/Verfügbare Konfigurationen



5) 8512374



6) 8512376



7) 8512474



8) 8512476

Przykładowa konfiguracja/Example configuration/Beispielkonfiguration

JENTA

Wymiary Dimensions Maße	Lp. No. Lfd. Nr.	Nr art. Item No. Art.-Nr.	Kolor - Color - Farbe		Materiał Material Material	Oprawka Socket Fassung
			Podstawa - Base - Basis	Abażur - Shade - Schirm		
	1	8512174	Dąb olejowany Oiled oak Eiche geölt	Biały White Weiss	Drewno dębowe/Tkanina Oak wood/Fabric Eichenholz/Stoff	1xE27 max. 25 W
	2	8512176	Orzech Walnut Walnuss		Drewno bukowe/Tkanina Beech wood/Fabric Buchenholz/Stoff	
	3	8512274	Dąb olejowany Oiled oak Eiche geölt		Drewno dębowe/Tkanina Oak wood/Fabric Eichenholz/Stoff	2xE27 max. 25 W
	4	8512276	Orzech Walnut Walnuss		Drewno bukowe/Tkanina Beech wood/Fabric Buchenholz/Stoff	
	5	8512374	Dąb olejowany Oiled oak Eiche geölt		Drewno dębowe/Tkanina Oak wood/Fabric Eichenholz/Stoff	3xE27 max. 25 W
	6	8512376	Orzech Walnut Walnuss		Drewno bukowe/Tkanina Beech wood/Fabric Buchenholz/Stoff	
	7	8512474	Dąb olejowany Oiled oak Eiche geölt		Drewno dębowe/Tkanina Oak wood/Fabric Eichenholz/Stoff	4xE27 max. 25 W
	8	8512476	Orzech Walnut Walnuss		Drewno bukowe/Tkanina Beech wood/Fabric Buchenholz/Stoff	
	9	7522174	Dąb olejowany Oiled oak Eiche geölt		Drewno dębowe/Tkanina Oak wood/Fabric Eichenholz/Stoff	1xE27 max. 25 W
	10	7522176	Orzech Walnut Walnuss		Drewno bukowe/Tkanina Beech wood/Fabric Buchenholz/Stoff	

Made in Europe

Nr abażura - Shade No. - Schirm-Nr. A0722

Z zastrzeżeniem zmian i możliwych błędów/Subject to changes and possible errors/Irtümer und Änderungen vorbehalten.



Przykładowa konfiguracja/Example configuration/Beispielkonfiguration

INGER

Wymiary Dimensions Maße	Lp. No. Lfd. Nr.	Nr art. Item No. Art.-Nr.	Kolor - Color - Farbe		Materiał Material Material	Oprawka Socket Fassung
			Podstawa - Base - Basis	Abażur - Shade - Schirm		
	1	2284174	Dąb olejowany Oiled oak Eiche geölt	Biały White Weiss	Drewno dębowe/Tkanina Oak wood/Fabric Eichenholz/Stoff	1xE27 max. 25 W
	2	2284176	Orzech Walnut Walnuss		Drewno bukowe/Tkanina Beech wood/Fabric Buchenholz/Stoff	
	3	2284274	Dąb olejowany Oiled oak Eiche geölt		Drewno dębowe/Tkanina Oak wood/Fabric Eichenholz/Stoff	2xE27 max. 25 W
	4	2284276	Orzech Walnut Walnuss		Drewno bukowe/Tkanina Beech wood/Fabric Buchenholz/Stoff	
	5	2284374	Dąb olejowany Oiled oak Eiche geölt		Drewno dębowe/Tkanina Oak wood/Fabric Eichenholz/Stoff	3xE27 max. 25 W
	6	2284376	Orzech Walnut Walnuss		Drewno bukowe/Tkanina Beech wood/Fabric Buchenholz/Stoff	
	7	2284474	Dąb olejowany Oiled oak Eiche geölt		Drewno dębowe/Tkanina Oak wood/Fabric Eichenholz/Stoff	4xE27 max. 25 W
	8	2284476	Orzech Walnut Walnuss		Drewno bukowe/Tkanina Beech wood/Fabric Buchenholz/Stoff	
	9	7284174	Dąb olejowany Oiled oak Eiche geölt		Drewno dębowe/Tkanina Oak wood/Fabric Eichenholz/Stoff	1xE27 max. 25 W
	10	7284176	Orzech Walnut Walnuss		Drewno bukowe/Tkanina Beech wood/Fabric Buchenholz/Stoff	

Made in Europe

Nr abażura - Shade No. - Schirm-Nr. A0994

Z zastrzeżeniem zmian i możliwych błędów/Subject to changes and possible errors/Irrtümer und Änderungen vorbehalten.

RIVOLI



1) 8582128



2) 8582228



3) 8582328



4) 8582428

Przykładowa konfiguracja/Example configuration/Beispielkonfiguration

Dostępne konfiguracje/Available configurations/Verfügbare Konfigurationen

RIVOLI						
Wymiary Dimensions Maße	Lp. No. Lfd. Nr.	Nr art. Item No. Art.-Nr.	Kolor - Color - Farbe		Materiał Material Material	Oprawka Socket Fassung
			Podstawa - Base - Basis	Abażur - Shade - Schirm		
	1	8582128	Chrom Chrome Chrom	Biały White Weiss	Metal/Tkanina Metal/Fabric Metall/Stoff	1xE27 max. 25 W
	2	8582228				2xE27 max. 25 W
	3	8582328				3xE27 max. 25 W
	4	8582428				4xE27 max. 25 W

Made in Europe

Nr abażura - Shade No. - Schirm-Nr. A0994

Z zastrzeżeniem zmian i możliwych błędów/Subject to changes and possible errors/Irrtümer und Änderungen vorbehalten.

NORMAN WOOD



9) 9175974



10) 9175960

Przykładowa konfiguracja/Example configuration/Beispielkonfiguration



1) 8175174



3) 8175274



5) 8175374



7) 8175474

Przykładowa konfiguracja/Example configuration/Beispielkonfiguration

NORMAN WOOD



Dostępne konfiguracje/Available configurations/Verfügbare Konfigurationen

NORMAN WOOD



2) 8175160

4) 8175260

6) 8175360

8) 8175460

Wymiary Dimensions Maße	Lp. No. Lfd. Nr.	Nr art. Item No. Art.-Nr.	Kolor - Color - Farbe		Materiał Material Material	Oprawka Socket Fassung
			Podstawa - Base - Basis	Klosz - Shade - Schirm		
	1	8175174	Dąb olejowany Oiled oak Eiche geölt	Chrom Chrome Chrom	Drewno dębowe/Metal Oak wood/Metal Eichenholz/Metall	1xE27 max. 25 W
	2	8175160	Brzoza Birch Birke		Drewno brzozowe/Metal Birch wood/Metal Birkenholz/Metall	
	3	8175274	Dąb olejowany Oiled oak Eiche geölt		Drewno dębowe/Metal Oak wood/Metal Eichenholz/Metall	2xE27 max. 25 W
	4	8175260	Brzoza Birch Birke		Drewno brzozowe/Metal Birch wood/Metal Birkenholz/Metall	
	5	8175374	Dąb olejowany Oiled oak Eiche geölt		Drewno dębowe/Metal Oak wood/Metal Eichenholz/Metall	3xE27 max. 25 W
	6	8175360	Brzoza Birch Birke		Drewno brzozowe/Metal Birch wood/Metal Birkenholz/Metall	
	7	8175474	Dąb olejowany Oiled oak Eiche geölt		Drewno dębowe/Metal Oak wood/Metal Eichenholz/Metall	4xE27 max. 25 W
	8	8175460	Brzoza Birch Birke		Drewno brzozowe/Metal Birch wood/Metal Birkenholz/Metall	
	9	9175974	Dąb olejowany Oiled oak Eiche geölt		Drewno dębowe/Metal Oak wood/Metal Eichenholz/Metall	1xE27 max. 25 W
	10	9175960	Brzoza Birch Birke		Drewno brzozowe/Metal Birch wood/Metal Birkenholz/Metall	

Made in Europe

Nr klosza - Shade No. - Schirm Nr. G0598

Przykładowa konfiguracja/Example configuration/Beispielkonfiguration

Z zastrzeżeniem zmian i możliwych błędów/Subject to changes and possible errors/Irrtümer und Änderungen vorbehalten.

NORMAN



1) 8175128



2) 8175228



3) 8175328



4) 8175428

Dostępne konfiguracje/Available configurations/Verfügbare Konfigurationen

NORMAN

Wymiary Dimensions Maße	Lp. No. Lfd. Nr.	Nr art. Item No. Art.-Nr.	Kolor Color Farbe	Materiał Material Material	Oprawka Socket Fassung
	1	8175128	Chrom Chrome Chrom	Metal Metal Metall	1xE27 max. 25 W
	2	8175228			2xE27 max. 25 W
	3	8175328			3xE27 max. 25 W
	4	8175428			4xE27 max. 25 W

Made in Europe

Nr klosza - Shade No. - Schirm Nr. G0598

Przykładowa konfiguracja/Example configuration/Beispielkonfiguration

Z zastrzeżeniem zmian i możliwych błędów/Subject to changes and possible errors/Irrtümer und Änderungen vorbehalten.



3) 8341328



5) 8341528

Przykładowa konfiguracja/Example configuration/Beispielkonfiguration

Dostępne konfiguracje/Available configurations/Verfügbare Konfigurationen

METTE

Wymiary Dimensions Maße	Lp. No. Lfd. Nr.	Nr art. Item No. Art.-Nr.	Kolor - Color - Farbe		Materiał Material Material	Oprawka Socket Fassung	
			Korpus - Base - Basis	Abażur - Shade - Schirm			
	1	8341128	Chrom Chrome Chrom	Biały White Weiss	Metal/Tkanina Metal/Fabric Metall/Stoff	1xE27 max. 40 W	
	2	8341127	Satyna Satin Satin				
	3	8341328	Chrom Chrome Chrom			3xE27 max. 40 W	
	4	8341327	Satyna Satin Satin				
	5	8341528	Chrom Chrome Chrom				5xE27 max. 40 W
	6	8341527	Satyna Satin Satin				

Made in Europe

Nr abażura - Shade No. - Schirm-Nr. A1041

Z zastrzeżeniem zmian i możliwych błędów/Subject to changes and possible errors/Irtümer und Änderungen vorbehalten.

METTE WOOD



1) 8341174



3) 8341374



5) 8341574

Przykładowa konfiguracja/Example configuration/Beispielkonfiguration

METTE WOOD



2) 8341176



4) 8341376



6) 8341576

Przykładowa konfiguracja/Example configuration/Beispielkonfiguration



Dostępne konfiguracje/Available configurations/Verfügbare Konfigurationen

METTE WOOD

Wymiary Dimensions Maße	Lp. No. Lfd. Nr.	Nr art. Item No. Art.-Nr.	Kolor - Color - Farbe		Materiał Material Material	Oprawka Socket Fassung
			Korpus - Base - Basis	Abażur - Shade - Schirm		
	1	8341174	Dąb olejowany/Chrom Oiled oak/Chrome Eiche geölt/Chrom	Biały White Weiss	Drewno dębowe/Metal/Tkanina Oak wood/Metal/Fabric Eichenholz/Metall/Stoff	1xE27 max. 40 W
	2	8341176	Orzech/Chrom Walnut/Chrome Nussbaum/Chrom		Drewno bukowe/Metal/Tkanina Beech wood/Metal/Fabric Buchenholz/Metall/Stoff	
	3	8341374	Dąb olejowany/Chrom Oiled oak/Chrome Eiche geölt/Chrom		Drewno dębowe/Metal/Tkanina Oak wood/Metal/Fabric Eichenholz/Metall/Stoff	3xE27 max. 40 W
	4	8341376	Orzech/Chrom Walnut/Chrome Nussbaum/Chrom		Drewno bukowe/Metal/Tkanina Beech wood/Metal/Fabric Buchenholz/Metall/Stoff	
	5	8341574	Dąb olejowany/Chrom Oiled oak/Chrome Eiche geölt/Chrom		Drewno dębowe/Metal/Tkanina Oak wood/Metal/Fabric Eichenholz/Metall/Stoff	5xE27 max. 40 W
	6	8341576	Orzech/Chrom Walnut/Chrome Nussbaum/Chrom		Drewno bukowe/Metal/Tkanina Beech wood/Metal/Fabric Buchenholz/Metall/Stoff	

Made in Europe

Nr abażura - Shade No. - Schirm-Nr. A1041

Z zastrzeżeniem zmian i możliwych błędów/Subject to changes and possible errors/Irtümer und Änderungen vorbehalten.

VILETTA WOOD



3) 8141176



6) 8141376



7) 8141574



VILETTA WOOD



2) 8142174



5) 8142374



8) 8152574

Dostępne konfiguracje/Available configurations/Verfügbare Konfigurationen



VILETTA WOOD

Wymiary Dimensions Maße	Lp. No. Lfd. Nr.	Nr art. Item No. Art.-Nr.	Kolor - Color - Farbe		Materiał Material Material	Oprawka Socket Fassung
			Korpus - Base - Basis	Szkoło - Glass - Glas		
	1	8141174	Dąb olejowany/Chrom Oiled oak/Chrome Eiche geölt/Chrom	Biały White Weiss	Drewno dębowe/Metal/Szkoło Oak wood/Metal/Glass Eichenholz/Metall/Glas	1xE27 max. 60 W
	2	8142174	Dąb olejowany/Czarny matowy Oiled oak/Matt black Eiche geölt/Schwarz Matt			
	3	8141176	Orzech/Chrom Walnut/Chrome Nussbaum/Chrom			
	4	8141374	Dąb olejowany/Chrom Oiled oak/Chrome Eiche geölt/Chrom		Drewno dębowe/Metal/Szkoło Oak wood/Metal/Glass Eichenholz/Metall/Glas	3xE27 max. 60 W
	5	8142374	Dąb olejowany/Czarny matowy Oiled oak/Matt black Eiche geölt/Schwarz Matt			
	6	8141376	Orzech/Chrom Walnut/Chrome Nussbaum/Chrom			
	7	8141574	Dąb olejowany/Chrom Oiled oak/Chrome Eiche geölt/Chrom		Drewno dębowe/Metal/Szkoło Oak wood/Metal/Glass Eichenholz/Metall/Glas	5xE27 max. 60 W
	8	8152574	Dąb olejowany/Czarny matowy Oiled oak/Matt black Eiche geölt/Schwarz Matt			
	9	8141576	Orzech/Chrom Walnut/Chrome Nussbaum/Chrom			

Made in Europe

Nr szkła - Glass No. - Glas-Nr. G0590

Z zastrzeżeniem zmian i możliwych błędów/Subject to changes and possible errors/Irrtümer und Änderungen vorbehalten.

PARMA WOOD



1) 8320174



3) 8320374



5) 8320574

Przykładowa konfiguracja/Example configuration/Beispielkonfiguration

PARMA WOOD



2) 8320176



4) 8320376



6) 8320576

Przykładowa konfiguracja/Example configuration/Beispielkonfiguration



Dostępne konfiguracje/Available configurations/Verfügbare Konfigurationen

PARMA WOOD

Wymiary Dimensions Maße	Lp. No. Lfd. Nr.	Nr art. Item No. Art.-Nr.	Kolor - Color - Farbe		Materiał Material Material	Oprawka Socket Fassung
			Korpus - Base - Basis	Szkoło - Glass - Glas		
	1	8320174	Dąb olejowany/Chrom Oiled oak/Chrome Eiche geölt/Chrom	Biały White Weiss	Drewno dębowe/Metal/Szkoło Oak wood/Metal/Glass Eichenholz/Metall/Glas	1xE27 max. 60 W
	2	8320176	Orzech/Chrom Walnut/Chrome Nussbaum/Chrom		Drewno bukowe/Metal/Szkoło Beech wood/Metal/Glass Buchenholz/Metall/Glas	
	3	8320374	Dąb olejowany/Chrom Oiled oak/Chrome Eiche geölt/Chrom		Drewno dębowe/Metal/Szkoło Oak wood/Metal/Glass Eichenholz/Metall/Glas	3xE27 max. 60 W
	4	8320376	Orzech/Chrom Walnut/Chrome Nussbaum/Chrom		Drewno bukowe/Metal/Szkoło Beech wood/Metal/Glass Buchenholz/Metall/Glas	
	5	8320574	Dąb olejowany/Chrom Oiled oak/Chrome Eiche geölt/Chrom		Drewno dębowe/Metal/Szkoło Oak wood/Metal/Glass Eichenholz/Metall/Glas	5xE27 max. 60 W
	6	8320576	Orzech/Chrom Walnut/Chrome Nussbaum/Chrom		Drewno bukowe/Metal/Szkoło Beech wood/Metal/Glass Buchenholz/Metall/Glas	

Made in Europe

Nr szkła - Glass No. - Glas-Nr. G0997

Z zastrzeżeniem zmian i możliwych błędów/Subject to changes and possible errors/Irrtümer und Änderungen vorbehalten.

SUNNIVA



1) 2291174



7) 2291474



4) 2291276



6) 2291376

Dostępne konfiguracje/Available configurations/Verfügbare Konfigurationen



SUNNIVA

Wymiary Dimensions Maße	Lp. No. Lfd. Nr.	Nr art. Item No. Art.-Nr.	Kolor Color Farbe	Materiał Material Material	Źródło światła Light source Lichtquelle
	1	2291174	Dąb olejowany/Satyna Oiled Oak/Satin Eiche geölt/Satin	Drewno dębowe/Metal Oak wood/Metal Eichenholz/Metall	Incl. 1xLED 5 W 300 lm, 3000 K
	2	2291176	Orzech /Satyna Walnut/Satin Nussbaum/Satin	Drewno bukowe/Metal Beech wood/Metal Buchenholz/Metall	
	3	2291274	Dąb olejowany/Satyna Oiled Oak/Satin Eiche geölt/Satin	Drewno dębowe/Metal Oak wood/Metal Eichenholz/Metall	Incl. 2xLED 5 W 300 lm, 3000 K
	4	2291276	Orzech /Satyna Walnut/Satin Nussbaum/Satin	Drewno bukowe/Metal Beech wood/Metal Buchenholz/Metall	
	5	2291374	Dąb olejowany/Satyna Oiled Oak/Satin Eiche geölt/Satin	Drewno dębowe/Metal Oak wood/Metal Eichenholz/Metall	Incl. 3xLED 5 W 300 lm, 3000 K
	6	2291376	Orzech /Satyna Walnut/Satin Nussbaum/Satin	Drewno bukowe/Metal Beech wood/Metal Buchenholz/Metall	
	7	2291474	Dąb olejowany/Satyna Oiled Oak/Satin Eiche geölt/Satin	Drewno dębowe/Metal Oak wood/Metal Eichenholz/Metall	Incl. 4xLED 5 W 300 lm, 3000 K
	8	2291476	Orzech /Satyna Walnut/Satin Nussbaum/Satin	Drewno bukowe/Metal Beech wood/Metal Buchenholz/Metall	

Made in Europe

Przykładowa konfiguracja/Example configuration/Beispielkonfiguration

Z zastrzeżeniem zmian i możliwych błędów/Subject to changes and possible errors/Irrtümer und Änderungen vorbehalten.

FINN



Przykładowa konfiguracja/Example configuration/Beispielkonfiguration



3) 4022974



2) 4032976



Dostępne konfiguracje/Available configurations/Verfügbare Konfigurationen

FINN

Wymiary Dimensions Maße	Lp. No. Lfd. Nr.	Nr art. Item No. Art.-Nr.	Kolor - Color - Farbe		Materiał Material Material	Źródło światła Light source Lichtquelle
			Podstawa - Base - Basis	Szkoło - Glass - Glas		
	1	4032974	Dąb olejowany Oiled oak Eiche geölt	Biały-Transparentny White-Transparent Weiss-Transparent	Drewno dębowe/Szkoło Oak wood/Glass Eichenholz/Glas	zintegrowane - integrated integriert 1xLED 24 W 2100 lm, 2700 K
	2	4032976	Orzech Walnut Walnuss		Drewno bukowe/Szkoło Beech wood/Glass Buchenholz/Glas	
	3	4022974	Dąb olejowany Oiled oak Eiche geölt		Drewno dębowe/Szkoło Oak wood/Glass Eichenholz/Glas	zintegrowane - integrated integriert 1xLED 14 W 1200 lm, 2700 K
	4	4022976	Orzech Walnut Walnuss		Drewno bukowe/Szkoło Beech wood/Glass Buchenholz/Glas	

Made in Europe

Nr szkła - Glass No. - Glas-Nr. G0905 (pos. 1-2), G0903 (pos. 3-4)

Z zastrzeżeniem zmian i możliwych błędów/Subject to changes and possible errors/Irrtümer und Änderungen vorbehalten.

FRIDA



5) 4754174



1) 4753174



2) 4753176



6) 4754176

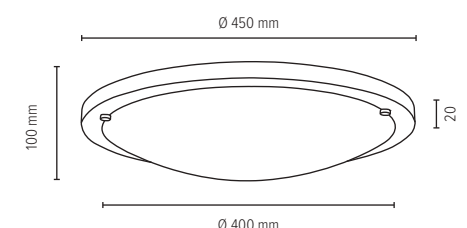
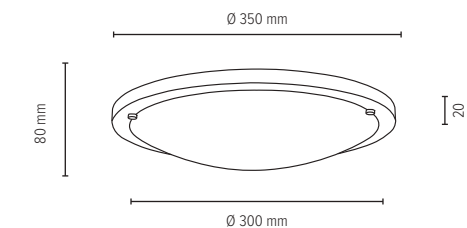

Dostępne konfiguracje/Available configurations/Verfügbare Konfigurationen



FRIDA

Wymiary Dimensions Maße	Lp. No. Lfd. Nr.	Nr art. Item No. Art.-Nr.	Źródło światła Light source Lichtquelle	Kolor - Color - Farbe		Materiał Material Material
				Podstawa - Base - Basis	Szkoło - Glass - Glas	
	1	4753174	zintegrowane - integrated integriert	Dąb olejowany Oiled oak Eiche geölt	Biały White Weiss	Drewno dębowe/Szkoło Oak wood/Glass Eichenholz/Glas
	2	4753176	1xLED 13 W 1200 lm, 2700 K	Orzech Walnut Walnuss		Drewno bukowe/Szkoło Beech wood/Glass Buchenholz/Glas
	3	4753474	2xE27 max. 40 W	Dąb olejowany Oiled oak Eiche geölt		Drewno dębowe/Szkoło Oak wood/Glass Eichenholz/Glas
	4	4753476		Orzech Walnut Walnuss		Drewno bukowe/Szkoło Beech wood/Glass Buchenholz/Glas
	5	4754174	zintegrowane - integrated integriert	Dąb olejowany Oiled oak Eiche geölt		Drewno dębowe/Szkoło Oak wood/Glass Eichenholz/Glas
	6	4754176	1xLED 18 W 1650 lm, 2700 K	Orzech Walnut Walnuss		Drewno bukowe/Szkoło Beech wood/Glass Buchenholz/Glas
	7	4754474	3xE27 max. 40 W	Dąb olejowany Oiled oak Eiche geölt		Drewno dębowe/Szkoło Oak wood/Glass Eichenholz/Glas
	8	4754476		Orzech Walnut Walnuss		Drewno bukowe/Szkoło Beech wood/Glass Buchenholz/Glas

Made in Europe

Nr szkła - Glass No. - Glas-Nr. G0651 (pos. 1-4), G0652 (pos. 5-8)

Z zastrzeżeniem zmian i możliwych błędów/Subject to changes and possible errors/Irtümer und Änderungen vorbehalten.

TREEHOUSE



1) 2236174



3) 2236274



6) 2236376



8) 2236476

Przykładowa konfiguracja/Example configuration/Beispielkonfiguration



Dostępne konfiguracje/Available configurations/Verfügbare Konfigurationen



TREEHOUSE

Wymiary Dimensions Maße	Lp. No. Lfd. Nr.	Nr art. Item No. Art.-Nr.	Kolor - Color - Farbe		Materiał Material Material	Oprawka Socket Fassung
			Podstawa - Base - Basis	Abażur - Shade - Schirm		
	1	2236174	Dąb olejowany Oiled oak Eiche geölt	Biały White Weiss	Drewno dębowe/Tkanina Oak wood/Fabric Eichenholz/Stoff	1xE27 max. 25 W
	2	2236176	Orzech Walnut Walnuss		Drewno bukowe/Tkanina Beech wood/Fabric Buchenholz/Stoff	
	3	2236274	Dąb olejowany Oiled oak Eiche geölt		Drewno dębowe/Tkanina Oak wood/Fabric Eichenholz/Stoff	2xE27 max. 25 W
	4	2236276	Orzech Walnut Walnuss		Drewno bukowe/Tkanina Beech wood/Fabric Buchenholz/Stoff	
	5	2236374	Dąb olejowany Oiled oak Eiche geölt		Drewno dębowe/Tkanina Oak wood/Fabric Eichenholz/Stoff	3xE27 max. 25 W
	6	2236376	Orzech Walnut Walnuss		Drewno bukowe/Tkanina Beech wood/Fabric Buchenholz/Stoff	
	7	2236474	Dąb olejowany Oiled oak Eiche geölt		Drewno dębowe/Tkanina Oak wood/Fabric Eichenholz/Stoff	4xE27 max. 25 W
	8	2236476	Orzech Walnut Walnuss		Drewno bukowe/Tkanina Beech wood/Fabric Buchenholz/Stoff	

Made in Europe

Nr abażura/Shade No./Schirm-Nr.: A0996

Z zastrzeżeniem zmian i możliwych błędów/Subject to changes and possible errors/Irrtümer und Änderungen vorbehalten.

BALL



2) 5109184



6) 5109282



7) 5109387



11) 5109484

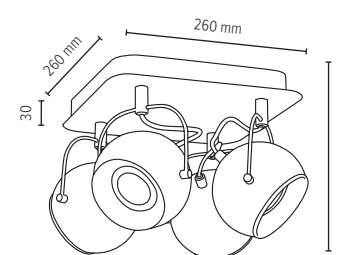
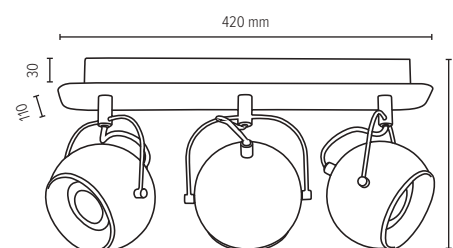
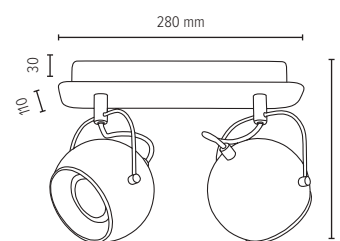
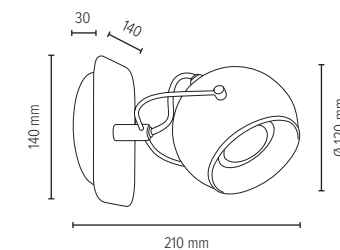

Dostępne konfiguracje/Available configurations/Verfügbare Konfigurationen

BALL

Wymiary Dimensions Maße	Lp. No. Lfd. Nr.	Nr art. Item No. Art.-Nr.	Kolor/Wykończenie Color/Finish Farbe/Finish	Materiał Material Material	Źródło światła Light source Lichtquelle
	1	5109187	Satyna/Chrom Satin/Chrome Satini/Chrom	Metal - Metal - Metall	Incl. 1xLED GU10 5 W 320 lm, 2700 K, Ra>90
	2	5109184	Czarny/Chrom Black/Chrome Schwarz/Chrom		
	3	5109182	Biały/Chrom White/Chrome Weiss/Chrom		
	4	5109287	Satyna/Chrom Satin/Chrome Satini/Chrom		Incl. 2xLED GU10 5 W 320 lm, 2700 K, Ra>90
	5	5109284	Czarny/Chrom Black/Chrome Schwarz/Chrom		
	6	5109282	Biały/Chrom White/Chrome Weiss/Chrom		
	7	5109387	Satyna/Chrom Satin/Chrome Satini/Chrom		Incl. 3xLED GU10 5 W 320 lm, 2700 K, Ra>90
	8	5109384	Czarny/Chrom Black/Chrome Schwarz/Chrom		
	9	5109382	Biały/Chrom White/Chrome Weiss/Chrom		
	10	5109487	Satyna/Chrom Satin/Chrome Satini/Chrom		Incl. 4xLED GU10 5 W 320 lm, 2700 K, Ra>90
	11	5109484	Czarny/Chrom Black/Chrome Schwarz/Chrom		
	12	5109482	Biały/Chrom White/Chrome Weiss/Chrom		

Made in Europe

Przykładowa konfiguracja/Example configuration/Beispielkonfiguration

Z zastrzeżeniem zmian i możliwych błędów/Subject to changes and possible errors/Irrtümer und Änderungen vorbehalten.

BALL WOOD



2) 5133174



4) 5133176



5) 5131274



7) 5131276

BALL WOOD



Dostępne konfiguracje/Available configurations/Verfügbare Konfigurationen



12) 5133376



9) 5131374



19) 5131476



18) 5133474

BALL WOOD

Wymiary Dimensions Maße	Lp. No. Lfd. Nr.	Nr art. Item No. Art.-Nr.	Kolor - Color - Farbe		Materiał Material Material	Źródło światła Light source Lichtquelle
			Podstawa - Base - Basis	Klosz - Head - Kopf		
	1	5131174	Dąb olejowany Oiled oak	Satyna - Satin - Satin	Drewno dębowe/Metal Oak wood/Metal Eichenholz/Metall	Incl. 1xLED GU10 5 W 320 lm, 2700 K, Ra>90
	2	5133174	Eiche geölt	Czarny - Black - Schwarz		
	3	5131176	Orzech Walnut	Satyna - Satin - Satin	Drewno bukowe/Metal Beech wood/Metal Buchenholz/Metall	
	4	5133176	Walnuss	Czarny - Black - Schwarz		
	5	5131274	Dąb olejowany Oiled oak	Satyna - Satin - Satin	Drewno dębowe/Metal Oak wood/Metal Eichenholz/Metall	Incl. 2xLED GU10 5 W 320 lm, 2700 K, Ra>90
	6	5133274	Eiche geölt	Czarny - Black - Schwarz		
	7	5131276	Orzech Walnut	Satyna - Satin - Satin	Drewno bukowe/Metal Beech wood/Metal Buchenholz/Metall	
	8	5133276	Walnuss	Czarny - Black - Schwarz		
	9	5131374	Dąb olejowany Oiled oak	Satyna - Satin - Satin	Drewno dębowe/Metal Oak wood/Metal Eichenholz/Metall	Incl. 3xLED GU10 5 W 320 lm, 2700 K, Ra>90
	10	5133374	Eiche geölt	Czarny - Black - Schwarz		
	11	5131376	Orzech Walnut	Satyna - Satin - Satin	Drewno bukowe/Metal Beech wood/Metal Buchenholz/Metall	
	12	5133376	Walnuss	Czarny - Black - Schwarz		
	13	5131474L	Dąb olejowany Oiled oak	Satyna - Satin - Satin	Drewno dębowe/Metal Oak wood/Metal Eichenholz/Metall	Incl. 4xLED GU10 5 W 320 lm, 2700 K, Ra>90
	14	5133474L	Eiche geölt	Czarny - Black - Schwarz		
	15	5131476L	Orzech Walnut	Satyna - Satin - Satin	Drewno bukowe/Metal Beech wood/Metal Buchenholz/Metall	
	16	5133476L	Walnuss	Czarny - Black - Schwarz		
	17	5131474	Dąb olejowany Oiled oak	Satyna - Satin - Satin	Drewno dębowe/Metal Oak wood/Metal Eichenholz/Metall	Incl. 4xLED GU10 5 W 320 lm, 2700 K, Ra>90
	18	5133474	Eiche geölt	Czarny - Black - Schwarz		
	19	5131476	Orzech Walnut	Satyna - Satin - Satin	Drewno bukowe/Metal Beech wood/Metal Buchenholz/Metall	
	20	5133476	Walnuss	Czarny - Black - Schwarz		

Made in Europe

Z zastrzeżeniem zmian i możliwych błędów/Subject to changes and possible errors/Irtümer und Änderungen vorbehalten.

WOOD

Każde drzewo, każdy kawałek drewna jest inny. Każdy z nich opowiada własną historię - o swoim pochodzeniu, warunkach wzrostu i procesie obróbki. Każda drewniana oprawa oświetleniowa powstająca w naszej firmie jest unikatem tworzonym z pasją i kreatywnością. Punktem wyjścia jest oryginalny pomysł na produkt, który nasz dział technologiczny przelewa na papier a stolarnia urzeczywistnia wykonując prototyp. Po fazie testów, modyfikacji i certyfikacji nowy model lampy wchodzi do produkcji seryjnej. O jakość obróbki drewna na każdym etapie dbają wysokiej klasy specjaliści. Ich kunszt rzemieślniczy w połączeniu z dynamicznym zarządzaniem i nowoczesnym parkiem maszynowym stanowią nasz największy kapitał.

Every tree and every piece of wood is different. It tells us its very own story - about its origin, growth conditions and its processing. Each wooden lighting fixture created in our company with passion and creativity is unique. It all starts with an original idea for the product, which our technology department captures on paper and the carpentry workshop brings into life by making a prototype. After the testing, modification and certification phase, the new lamp model goes into series production. High-class specialists ensure the quality of wood processing at every stage. Their craftsmanship combined with dynamic management and modern machine park are our greatest capital.

Jeder Baum und jedes Stück Holz ist anders. Es erzählt uns seine ganz eigene Geschichte - von seiner Herkunft, seinem Wachstum und seiner Verarbeitung. Jede unserer Holzlampen ist ein Unikat, das mit Leidenschaft und Kreativität geschaffen wurde. Am Anfang steht eine originelle Produktidee, die unsere Technologieabteilung auf Papier festhält und die Tischlerei verwirklicht, indem sie einen Prototyp herstellt. Nach der Test-, Änderungs- und Zertifizierungsphase geht das neue Lampenmodell in Serie. Erfahrene Spezialisten sorgen für die höchste Qualität der Holzverarbeitung. Ihre Handwerkskunst kombiniert mit dynamischem Management und modernem Maschinenpark sind unser größtes Kapital.

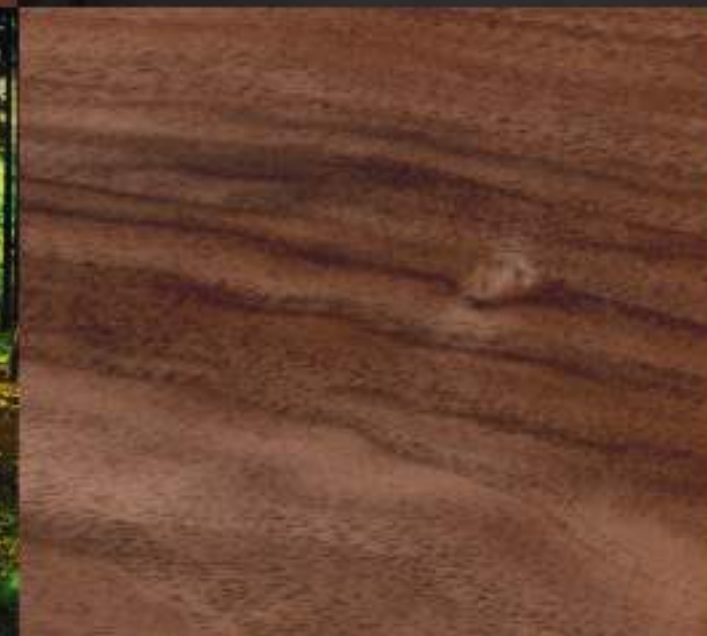

SVENDA



2) 2224132



8) 2224260



1) 2224174



7) 2224276



12) 2224360

10) 2224332

15) 2224476

Przykładowa konfiguracja/Example configuration/Beispielkonfiguration

Wymiary Dimensions Maße	Lp. No. Lfd. Nr.	Nr art. Item No. Art.-Nr.	Kolor - Color - Farbe		Materiał Material Material	Oprawka Socket Fassung
			Podstawa - Base - Basis	Klosz - Shade - Schirm		
	1	2224174	Dąb olejowany Oiled oak Eiche geölt	Biały White Weiss	Drewno dębowe/Metal Oak wood/Metal Eichenholz/Metall	1xE27 max. 60 W
	2	2224132	Dąb bielony Oak White Eiche Weiss			
	3	2224176	Orzech Walnut Walnuss			
	4	2224160	Brzoza Birch Birke			
	5	2224274	Dąb olejowany Oiled oak Eiche geölt		Drewno dębowe/Metal Oak wood/Metal Eichenholz/Metall	2xE27 max. 60 W
	6	2224232	Dąb bielony Oak White Eiche Weiss			
	7	2224276	Orzech Walnut Walnuss			
	8	2224260	Brzoza Birch Birke			
	9	2224374	Dąb olejowany Oiled oak Eiche geölt		Drewno dębowe/Metal Oak wood/Metal Eichenholz/Metall	3xE27 max. 60 W
	10	2224332	Dąb bielony Oak White Eiche Weiss			
	11	2224376	Orzech Walnut Walnuss			
	12	2224360	Brzoza Birch Birke			
	13	2224474	Dąb olejowany Oiled oak Eiche geölt		Drewno dębowe/Metal Oak wood/Metal Eichenholz/Metall	4xE27 max. 60 W
	14	2224432	Dąb bielony Oak White Eiche Weiss			
	15	2224476	Orzech Walnut Walnuss			
	16	2224460	Brzoza Birch Birke			

Made in Europe

Nr klosza - Shade No. - Schirm-Nr. G0960

SVANTJE



3) 2239160



4) 2239274



9) 2239360



10) 2239474

Przykładowa konfiguracja/Example configuration/Beispielkonfiguration



2) 2239176

5) 2239276



8) 2239376



11) 2239476

SVANTJE						
Wymiary Dimensions Maße	Lp. No. Lfd. Nr.	Nr art. Item No. Art.-Nr.	Kolor - Color - Farbe		Materiał Material Material	Oprawka Socket Fassung
			Podstawa - Base - Basis	Klosz - Shade - Schirm		
	1	2239174	Dąb olejowany Oiled oak Eiche geölt	Biały White Weiss	Drewno dębowe/Metal Oak wood/Metal Eichenholz/Metall	1xE14 max. 40 W
	2	2239176	Orzech Walnut Walnuss		Drewno bukowe/Metal Beech wood/Metal Buchenholz/Metall	
	3	2239160	Brzoza Birch Birke		Drewno brzozone/Metal Birch wood/Metal Birkenholz/Metall	
	4	2239274	Dąb olejowany Oiled oak Eiche geölt		Drewno dębowe/Metal Oak wood/Metal Eichenholz/Metall	2xE14 max. 40 W
	5	2239276	Orzech Walnut Walnuss		Drewno bukowe/Metal Beech wood/Metal Buchenholz/Metall	
	6	2239260	Brzoza Birch Birke		Drewno brzozone/Metal Birch wood/Metal Birkenholz/Metall	
	7	2239374	Dąb olejowany Oiled oak Eiche geölt		Drewno dębowe/Metal Oak wood/Metal Eichenholz/Metall	3xE14 max. 40 W
	8	2239376	Orzech Walnut Walnuss		Drewno bukowe/Metal Beech wood/Metal Buchenholz/Metall	
	9	2239360	Brzoza Birch Birke		Drewno brzozone/Metal Birch wood/Metal Birkenholz/Metall	
	10	2239474	Dąb olejowany Oiled oak Eiche geölt		Drewno dębowe/Metal Oak wood/Metal Eichenholz/Metall	4xE14 max. 40 W
	11	2239476	Orzech Walnut Walnuss		Drewno bukowe/Metal Beech wood/Metal Buchenholz/Metall	
	12	2239460	Brzoza Birch Birke		Drewno brzozone/Metal Birch wood/Metal Birkenholz/Metall	

MEGAN



2) 2743102



3) 2743204



6) 2743302



7) 2743404

Przykładowa konfiguracja/Example configuration/Beispielkonfiguration

Dostępne konfiguracje/Available configurations/Verfügbare Konfigurationen

MEGAN

Wymiary Dimensions Maße	Lp. No. Lfd. Nr.	Nr art. Item No. Art.-Nr.	Kolor Color Farbe	Materiał Material Material	Oprawka Socket Fassung
	1	2743104	Czarny/Chrom - Black/Chrome - Schwarz/Chrom	Metal Metal Metall	1xE14 max. 40 W
	2	2743102	Biały/Chrom - White/Chrome - Weiss/Chrom		
	3	2743204	Czarny/Chrom - Black/Chrome - Schwarz/Chrom		2xE14 max. 40 W
	4	2743202	Biały/Chrom - White/Chrome - Weiss/Chrom		
	5	2743304	Czarny/Chrom - Black/Chrome - Schwarz/Chrom		3xE14 max. 40 W
	6	2743302	Biały/Chrom - White/Chrome - Weiss/Chrom		
	7	2743404	Czarny/Chrom - Black/Chrome - Schwarz/Chrom		4xE14 max. 40 W
	8	2743402	Biały/Chrom - White/Chrome - Weiss/Chrom		

Made in Europe

Z zastrzeżeniem zmian i możliwych błędów/Subject to changes and possible errors/Irrtümer und Änderungen vorbehalten.

MEGAN WOOD



6) 2344260



7) 2344374



8) 2344376

Przykładowa konfiguracja/Example configuration/Beispielkonfiguration

MEGAN WOOD

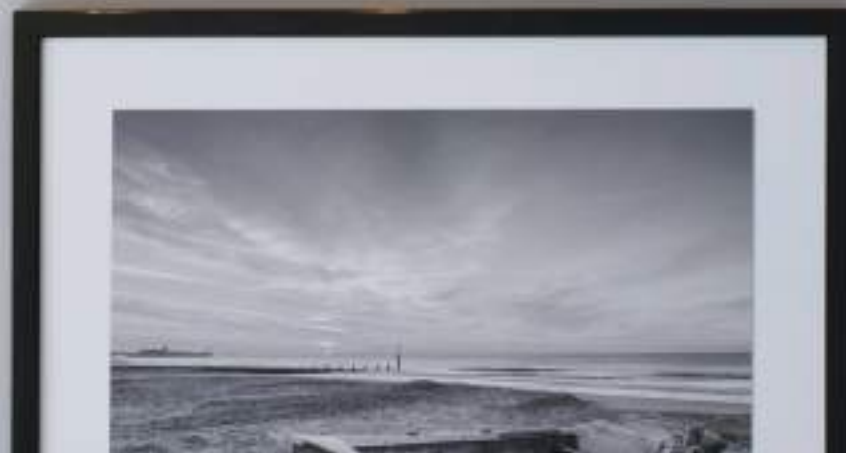
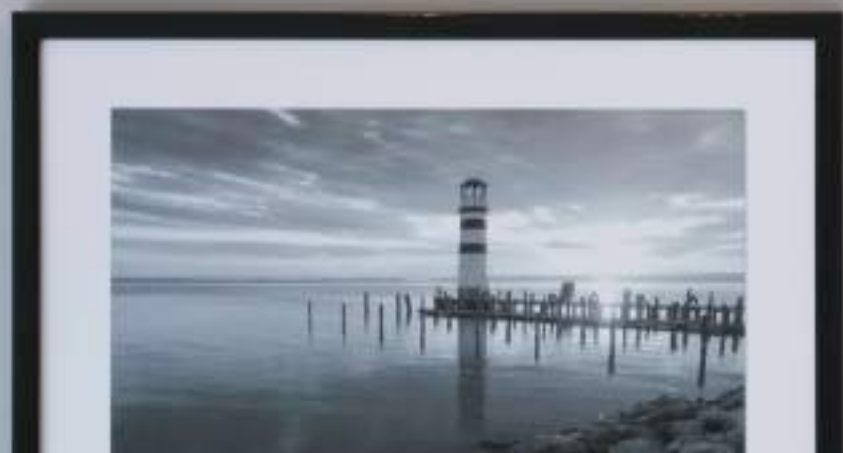

Dostępne konfiguracje/Available configurations/Verfügbare Konfigurationen

MEGAN WOOD

Wymiary Dimensions Maße	Lp. No. Lfd. Nr.	Nr art. Item No. Art.-Nr.	Kolor - Color - Farbe		Materiał Material Material	Oprawka Socket Fassung
			Podstawa - Base - Basis	Klosz - Head - Kopf		
	1	2344174	Dąb olejowany Oiled Oak Eiche geölt	Czarny Black Schwarz	Drewno dębowe/Metal Oak wood/Metal Eichenholz/Metall	1xE14 max. 40 W
	2	2344176	Orzech Walnut Nussbaum		Drewno bukowe/Metal Beech wood/Metal Buchenholz/Metall	
	3	2344160	Brzoza Birch Birke		Drewno brzozowe/Metal Birch wood/Metal Birkenholz/Metall	
	4	2344274	Dąb olejowany Oiled Oak Eiche geölt		Drewno dębowe/Metal Oak wood/Metal Eichenholz/Metall	2xE14 max. 40 W
	5	2344276	Orzech Walnut Nussbaum		Drewno bukowe/Metal Beech wood/Metal Buchenholz/Metall	
	6	2344260	Brzoza Birch Birke		Drewno brzozowe/Metal Birch wood/Metal Birkenholz/Metall	
	7	2344374	Dąb olejowany Oiled Oak Eiche geölt		Drewno dębowe/Metal Oak wood/Metal Eichenholz/Metall	3xE14 max. 40 W
	8	2344376	Orzech Walnut Nussbaum		Drewno bukowe/Metal Beech wood/Metal Buchenholz/Metall	
	9	2344360	Brzoza Birch Birke		Drewno brzozowe/Metal Birch wood/Metal Birkenholz/Metall	
	10	2344474	Dąb olejowany Oiled Oak Eiche geölt		Drewno dębowe/Metal Oak wood/Metal Eichenholz/Metall	4xE14 max. 40 W
	11	2344476	Orzech Walnut Nussbaum		Drewno bukowe/Metal Beech wood/Metal Buchenholz/Metall	
	12	2344460	Brzoza Birch Birke		Drewno brzozowe/Metal Birch wood/Metal Birkenholz/Metall	

Made in Europe

Z zastrzeżeniem zmian i możliwych błędów/Subject to changes and possible errors/Irtümer und Änderungen vorbehalten.

VENLA



1) 2434174



4) 2434274



9) 2434360



11) 2434476

Przykładowa konfiguracja/Example configuration/Beispielkonfiguration



Dostępne konfiguracje/Available configurations/Verfügbare Konfigurationen

VENLA

Wymiary Dimensions Maße	Lp. No. Lfd. Nr.	Nr art. Item No. Art.-Nr.	Kolor Color Farbe	Materiał Material Material	Źródło światła Light source Lichtquelle
	1	2434174	Dąb olejowany Oiled oak Eiche geölt	Drewno dębowe Oak wood Eichenholz	Incl. 1xLED GU10 5 W 320 lm, 2700 K, Ra>90
	2	2434176	Orzech Walnut Walnuss	Drewno bukowe Beech wood Buchenholz	
	3	2434160	Brzoza Birch Birke	Drewno brzożowe Birch wood Birkenholz	
	4	2434274	Dąb olejowany Oiled oak Eiche geölt	Drewno dębowe Oak wood Eichenholz	Incl. 2xLED GU10 5 W 320 lm, 2700 K, Ra>90
	5	2434276	Orzech Walnut Walnuss	Drewno bukowe Beech wood Buchenholz	
	6	2434260	Brzoza Birch Birke	Drewno brzożowe Birch wood Birkenholz	
	7	2434374	Dąb olejowany Oiled oak Eiche geölt	Drewno dębowe Oak wood Eichenholz	Incl. 3xLED GU10 5 W 320 lm, 2700 K, Ra>90
	8	2434376	Orzech Walnut Walnuss	Drewno bukowe Beech wood Buchenholz	
	9	2434360	Brzoza Birch Birke	Drewno brzożowe Birch wood Birkenholz	
	10	2434474	Dąb olejowany Oiled oak Eiche geölt	Drewno dębowe Oak wood Eichenholz	Incl. 4xLED GU10 5 W 320 lm, 2700 K, Ra>90
	11	2434476	Orzech Walnut Walnuss	Drewno bukowe Beech wood Buchenholz	
	12	2434460	Brzoza Birch Birke	Drewno brzożowe Birch wood Birkenholz	

Made in Europe

Z zastrzeżeniem zmian i możliwych błędów/Subject to changes and possible errors/Irrtümer und Änderungen vorbehalten.

BIRGIT



1) 2222174



6) 2222260



7) 2222374



11) 2222476

Przykładowa konfiguracja/Example configuration/Beispielkonfiguration



Dostępne konfiguracje/Available configurations/Verfügbare Konfigurationen



BIRGIT

Wymiary Dimensions Maße	Lp. No. Lfd. Nr.	Nr art. Item No. Art.-Nr.	Kolor - Color - Farbe		Materiał Material Material	Oprawka Socket Fassung
			Podstawa - Base - Basis	Klosz - Shade - Schirm		
	1	2222174	Dąb olejowany Oiled oak Eiche geölt	Szkło alabaster Alabaster glass Alabaster Glas	Drewno dębowe/Szkło Oak wood/Glass Eichenholz/Glas	1xE14 max. 40 W
	2	2222176	Orzech Walnut Walnuss		Drewno bukowe/Szkło Beech wood/Glass Buchenholz/Glas	
	3	2222160	Brzoza Birch Birke		Drewno brzozowe/Szkło Birch wood/Glass Birkenholz/Glas	
	4	2222274	Dąb olejowany Oiled oak Eiche geölt		Drewno dębowe/Szkło Oak wood/Glass Eichenholz/Glas	2xE14 max. 40 W
	5	2222276	Orzech Walnut Walnuss		Drewno bukowe/Szkło Beech wood/Glass Buchenholz/Glas	
	6	2222260	Brzoza Birch Birke		Drewno brzozowe/Szkło Birch wood/Glass Birkenholz/Glas	
	7	2222374	Dąb olejowany Oiled oak Eiche geölt		Drewno dębowe/Szkło Oak wood/Glass Eichenholz/Glas	3xE14 max. 40 W
	8	2222376	Orzech Walnut Walnuss		Drewno bukowe/Szkło Beech wood/Glass Buchenholz/Glas	
	9	2222360	Brzoza Birch Birke		Drewno brzozowe/Szkło Birch wood/Glass Birkenholz/Glas	
	10	2222474	Dąb olejowany Oiled oak Eiche geölt		Drewno dębowe/Szkło Oak wood/Glass Eichenholz/Glas	4xE14 max. 40 W
	11	2222476	Orzech Walnut Walnuss		Drewno bukowe/Szkło Beech wood/Glass Buchenholz/Glas	
	12	2222460	Brzoza Birch Birke		Drewno brzozowe/Szkło Birch wood/Glass Birkenholz/Glas	

Made in Europe

Nr szkła - Glass No. - Glas-Nr. G0122

Z zastrzeżeniem zmian i możliwych błędów/Subject to changes and possible errors/Irrtümer und Änderungen vorbehalten.

Dostępne konfiguracje/Available configurations/Verfügbare Konfigurationen



1) 2231174



5) 2231276



9) 2231360



11) 2231476

KARIN						
Wymiary Dimensions Maße	Lp. No. Lfd. Nr.	Nr art. Item No. Art.-Nr.	Kolor - Color - Farbe		Materiał Material Material	Oprawka Socket Fassung
			Podstawa - Base - Basis	Klosz - Shade -Schrim		
	1	2231174	Dąb olejowany Oiled oak Eiche geölt	Biały White Weiss	Drewno dębowe/Szkló Oak wood/Glass Eichenholz/Glas	1xE14 max. 40 W
	2	2231176	Orzech Walnut Walnuss		Drewno bukowe/Szkló Beech wood/Glass Buchenholz/Glas	
	3	2231160	Brzoza Birch Birke		Drewno brzozowe/Szkló Birch wood/Glass Birkenholz/Glas	
	4	2231274	Dąb olejowany Oiled oak Eiche geölt		Drewno dębowe/Szkló Oak wood/Glass Eichenholz/Glas	2xE14 max. 40 W
	5	2231276	Orzech Walnut Walnuss		Drewno bukowe/Szkló Beech wood/Glass Buchenholz/Glas	
	6	2231260	Brzoza Birch Birke		Drewno brzozowe/Szkló Birch wood/Glass Birkenholz/Glas	
	7	2231374	Dąb olejowany Oiled oak Eiche geölt		Drewno dębowe/Szkló Oak wood/Glass Eichenholz/Glas	3xE14 max. 40 W
	8	2231376	Orzech Walnut Walnuss		Drewno bukowe/Szkló Beech wood/Glass Buchenholz/Glas	
	9	2231360	Brzoza Birch Birke		Drewno brzozowe/Szkló Birch wood/Glass Birkenholz/Glas	
	10	2231474	Dąb olejowany Oiled oak Eiche geölt		Drewno dębowe/Szkló Oak wood/Glass Eichenholz/Glas	4xE14 max. 40 W
	11	2231476	Orzech Walnut Walnuss		Drewno bukowe/Szkló Beech wood/Glass Buchenholz/Glas	
	12	2231460	Brzoza Birch Birke		Drewno brzozowe/Szkló Birch wood/Glass Birkenholz/Glas	

Made in Europe

Nr szkła - Glass No. - Glas-Nr. G0768

WOODDREAM WALL



Przykładowa konfiguracja/Example configuration/Beispielkonfiguration



5) 2581260



1) 2581274



3) 2581276

Dostępne konfiguracje/Available configurations/Verfügbare Konfigurationen



WOODDREAM WALL

Wymiary Dimensions Maße	Lp. No. Lfd. Nr.	Nr art. Item No. Art.-Nr.	Źródło światła Light source Lichtquelle	Kolor drewna Wood color Holzfarbe	Materiał Material Material
	1	2581274	Incl. 2xLED GU10 5 W 320 lm, 2700 K, Ra>90	Dąb olejowany Oiled Oak Eiche geölt	Drewno dębowe Oak wood Eichenholz
	2	2081274	2xGU10 max. 6 W		
	3	2581276	Incl. 2xLED GU10 5 W 320 lm, 2700 K, Ra>90	Orzech Walnut Nussbaum	Drewno bukowe Beech wood Buchenholz
	4	2081276	2xGU10 max. 6 W		
	5	2581260	Incl. 2xLED GU10 5 W 320 lm, 2700 K, Ra>90	Brzoza Birch Birke	Drewno brzozowe Birch wood Birkenholz
	6	2081260	2xGU10 max. 6 W		

Made in Europe

Z zastrzeżeniem zmian i możliwych błędów/Subject to changes and possible errors/Irrtümer und Änderungen vorbehalten.

WOODDREAM WALL



Przykładowa konfiguracja/Example configuration/Beispielkonfiguration



5) 2571260



1) 2571274



3) 2571276

Dostępne konfiguracje/Available configurations/Verfügbare Konfigurationen



WOODDREAM WALL

Wymiary Dimensions Maße	Lp. No. Lfd. Nr.	Nr art. Item No. Art.-Nr.	Źródło światła Light source Lichtquelle	Kolor drewna Wood color Holzfarbe	Materiał Material Material
	1	2571274	Incl. 2xLED GU10 5 W 320 lm, 2700 K, Ra>90	Dąb olejowany Oiled Oak Eiche geölt	Drewno dębowe Oak wood Eichenholz
	2	2071274	2xGU10 max. 6 W		
	3	2571276	Incl. 2xLED GU10 5 W 320 lm, 2700 K, Ra>90	Orzech Walnut Nussbaum	Drewno bukowe Beech wood Buchenholz
	4	2071276	2xGU10 max. 6 W		
	5	2571260	Incl. 2xLED GU10 5 W 320 lm, 2700 K, Ra>90	Brzoza Birch Birke	Drewno brzozowe Birch wood Birkenholz
	6	2071260	2xGU10 max. 6 W		

Made in Europe

Z zastrzeżeniem zmian i możliwych błędów/Subject to changes and possible errors/Irtümer und Änderungen vorbehalten.

TREEHOUSE CLIPS



3) 2236174WF



4) 2236176F



1) 2236174WK



2) 2236176K

Dostępne konfiguracje/Available configurations/Verfügbare Konfigurationen



TREEHOUSE CLIPS

Wymiary Dimensions Maße	Lp. No. Lfd. Nr.	Nr art. Item No. Art.-Nr.	Kolor - Color - Farbe			Materiał Material Material	Oprawka Socket Fassung
			Oprawka - Socket Fassung	Zacisk - Clips Klemme	Abażur - Shade Schirm		
	1	2236174WK	Dąb olejowany Oiled oak Eiche geölt	Biały White Weiss	Biały White Weiss	Drewno dębowe/Tkanina/Metal/Tworzywo szt. Oak wood/Fabric/Metal/Synthetic Eichenholz/Stoff/Metall/Kunststoff	1xE27 max. 25 W
	2	2236176K	Orzech Walnut Walnuss	Czarny Black Schwarz		Drewno bukowe/Tkanina/Metal/Tworzywo szt. Beech wood/Fabric/Metal/Synthetic Buchenholz/Stoff/Metall/Kunststoff	
	3	2236174WF	Dąb olejowany Oiled oak Eiche geölt	Biały White Weiss	Drewno dębowe/Tkanina/Metal/Tworzywo szt. Oak wood/Fabric/Metal/Synthetic Eichenholz/Stoff/Metall/Kunststoff		
	4	2236176F	Orzech Walnut Walnuss	Czarny Black Schwarz	Drewno bukowe/Tkanina/Metal/Tworzywo szt. Beech wood/Fabric/Metal/Synthetic Buchenholz/Stoff/Metall/Kunststoff		

Made in Europe

Nr abażura/Shade No./Schirm-Nr.: A0996

Z zastrzeżeniem zmian i możliwych błędów/Subject to changes and possible errors/Irrtümer und Änderungen vorbehalten.

SVENDA CLIPS



2) 2224132WK



3) 2224160WK



5) 2224174WF



8) 2224176F

Przykładowa konfiguracja/Example configuration/Beispielkonfiguration



Dostępne konfiguracje/Available configurations/Verfügbare Konfigurationen



SVENDA CLIPS

Wymiary Dimensions Maße	Lp. No. Lfd. Nr.	Nr art. Item No. Art.-Nr.	Kolor - Color - Farbe			Materiał Material Material	Oprawka Socket Fassung
			Oprawka - Socket Fassung	Zacisk - Clip Klemme	Klosz - Shade Schirm		
	1	2224174WK	Dąb olejowany Oiled oak Eiche geölt	Biały White Weiss	Biały White Weiss	Drewno dębowe/Metal/Tworzywo szt. Oak wood/Metal/Synthetic Eichenholz/Metall/Kunststoff	1xE27 max. 60 W
	2	2224132WK	Dąb bielony Oak White Eiche Weiss				
	3	2224160WK	Brzoza Birch Birke				
	4	2224176K	Orzech Walnut Walnuss				
	5	2224174WF	Dąb olejowany Oiled oak Eiche geölt	Biały White Weiss	Biały White Weiss	Drewno dębowe/Metal/Tworzywo szt. Oak wood/Metal/Synthetic Eichenholz/Metall/Kunststoff	
	6	2224132WF	Dąb bielony Oak White Eiche Weiss				
	7	2224160WF	Brzoza Birch Birke				
	8	2224176F	Orzech Walnut Walnuss				

Made in Europe

Nr klosza - Shade No. - Schirm-Nr. G0960

Z zastrzeżeniem zmian i możliwych błędów/Subject to changes and possible errors/Irrtümer und Änderungen vorbehalten.

ASTRID CLIPS



1) 2735102K



2) 2735104K

Dostępne konfiguracje/Available configurations/Verfügbare Konfigurationen

ASTRID CLIPS

Wymiary Dimensions Maße	Lp. No. Lfd. Nr.	Nr art. Item No. Art.-Nr.	Kolor Color Farbe	Materiał Material Material	Oprawka Socket Fassung
	1	2735102K	Biały - White - Weiss	Metal Metal Metall	1xE14 max. 40 W
	2	2735104K	Czarny - Black - Schwarz		

Made in Europe

Z zastrzeżeniem zmian i możliwych błędów/Subject to changes and possible errors/Irtümer und Änderungen vorbehalten.

MEGAN CLIPS



1) 2743102K



2) 2743104K



Dostępne konfiguracje/Available configurations/Verfügbare Konfigurationen

MEGAN CLIPS

Wymiary Dimensions Maße	Lp. No. Lfd. Nr.	Nr art. Item No. Art.-Nr.	Kolor Color Farbe	Materiał Material Material	Oprawka Socket Fassung
	1	2743102K	Biały - White - Weiss	Metal Metal Metall	1xE14 max. 40 W
	2	2743104K	Czarny - Black - Schwarz		

Made in Europe

Z zastrzeżeniem zmian i możliwych błędów/Subject to changes and possible errors/Irtümer und Änderungen vorbehalten.

MARINNA



2) 7612074



3) 7615074

MARINNA



7) 7611042



6) 7615076



5) 7612076



8) 7615042

Przykładowa konfiguracja/Example configuration/Beispielkonfiguration

Przykładowa konfiguracja/Example configuration/Beispielkonfiguration

Dostępne konfiguracje/Available configurations/Verfügbare Konfigurationen



MARINNA

Wymiary Dimensions Maße	Lp. No. Lfd. Nr.	Nr art. Item No. Art.-Nr.	Kolor - Color - Farbe			Materiał Material Material	Oprawka Socket Fassung
			Podstawa - Base - Basis	Abażur - Shade - Schirm	Kabel - Cable - Kabel		
	1	7611074	Dąb olejowany Oiled oak Eiche geölt	Biały - White - Weiss	Transparentny Transparent Transparent	Drewno dębowe/Tkanina Oak wood/Fabric Eichenholz/Stoff	1xE27 max. 25 W
	2	7612074		Kremowy - Ecrú - Natur			
	3	7615074		Czarny - Black - Schwarz			
	4	7611076	Orzech Walnut Walnuss	Biały - White - Weiss			
	5	7612076		Kremowy - Ecrú - Natur			
	6	7615076		Czarny - Black - Schwarz			
	7	7611042	Biały White Weiss	Biały - White - Weiss			
	8	7615042		Czarny - Black - Schwarz			

Made in Europe

Nr abażura/Shade No./Schirm-Nr.: Strona/Page/Seite: 315.

Z zastrzeżeniem zmian i możliwych błędów/Subject to changes and possible errors/Irrtümer und Änderungen vorbehalten.

THEO



1) 7462174



2) 7462176



3) 7462160



Dostępne konfiguracje/Available configurations/Verfügbare Konfigurationen

THEO

Wymiary Dimensions Maße	Lp. No. Lfd. Nr.	Nr art. Item No. Art.-Nr.	Kolor - Color - Farbe			Materiał Material Material	Oprawka Socket Fassung
			Podstawa - Base - Basis	Abażur - Shade - Schirm	Kabel - Cable - Kabel		
	1	7462174	Dąb olejowany Oiled oak Eiche geölt	Biały White Weiss	Czarny Black Schwarz	Drewno dębowe/Tkanina Oak wood/Fabric Eichenholz/Stoff	1xE27 max. 25 W
	2	7462176	Orzech Walnut Walnuss				
	3	7462160	Brzoza Birch Birke				

Made in Europe

Nr abażura/Shade No./Schirm-Nr.: A1032

Z zastrzeżeniem zmian i możliwych błędów/Subject to changes and possible errors/Irrtümer und Änderungen vorbehalten.

THEO



1) 7461174



5) 7460176



3) 7461160



Dostępne konfiguracje/Available configurations/Verfügbare Konfigurationen

THEO

Wymiary Dimensions Maße	Lp. No. Lfd. Nr.	Nr art. Item No. Art.-Nr.	Ładowarka USB USB Charging Station USB Ladestation	Kolor drewna Wood color Holzfarbe	Materiał Material Material	Kolor kabla Cable Color Kabelfarbe	Oprawka Socket Fassung
	1	7461174	Zintegrowana Integrated Integriert	Dąb olejowany Oiled Oak Eiche geölt	Drewno dębowe Oak wood Eichenholz	Czarny Black Schwarz	1xE27 max. 25 W
	2	7461176		Orzech Walnut Nussbaum	Drewno bukowe Beech wood Buchenholz		
	3	7461160		Brzoza Birch Birke	Drewno brzozowe Birch wood Birkenholz		
	4	7460174	Brak None Keine	Dąb olejowany Oiled Oak Eiche geölt	Drewno dębowe Oak wood Eichenholz		
	5	7460176		Orzech Walnut Nussbaum	Drewno bukowe Beech wood Buchenholz		
	6	7460160		Brzoza Birch Birke	Drewno brzozowe Birch wood Birkenholz		

Made in Europe

Z zastrzeżeniem zmian i możliwych błędów/Subject to changes and possible errors/Irtümer und Änderungen vorbehalten.

VINCENT

Przykładowa konfiguracja/Example configuration/Beispielkonfiguration



1) 2266374



2) 2266376

Dostępne konfiguracje/Available configurations/Verfügbare Konfigurationen



VINCENT

Wymiary Dimensions Maße	Lp. No. Lfd. Nr.	Nr art. Item No. Art.-Nr.	Kolor drewna Wood color Holzfarbe	Materiał Material Material	Kolor kabla Cable color Kabelfarbe	Oprawka Socket Fassung
	1	2266374	Dąb olejowany Oiled Oak Eiche geölt	Drewno dębowe Oak wood Eichenholz	Czarny Black Schwarz	3xE27 max. 15 W
	2	2266376	Orzech Walnut Nussbaum	Drewno bukowe Beech wood Buchenholz		
	3	2266360	Brzoza Birch Birke	Drewno brzozowe Birch wood Birkenholz		

Made in Europe

Z zastrzeżeniem zmian i możliwych błędów/Subject to changes and possible errors/Irtümer und Änderungen vorbehalten.

VINCENT



Przykładowa konfiguracja/Example configuration/Beispielkonfiguration



3) 2276360



2) 2276376

Dostępne konfiguracje/Available configurations/Verfügbare Konfigurationen



VINCENT

Wymiary Dimensions Maße	Lp. No. Lfd. Nr.	Nr art. Item No. Art.-Nr.	Kolor drewna Wood color Holzfarbe	Materiał Material Material	Kolor kabla Cable color Kabelfarbe	Oprawka Socket Fassung
	1	2276374	Dąb olejowany Oiled Oak Eiche geölt	Drewno dębowe Oak wood Eichenholz	Czarny Black Schwarz	3xE27 max. 15 W
	2	2276376	Orzech Walnut Nussbaum	Drewno bukowe Beech wood Buchenholz		
	3	2276360	Brzoza Birch Birke	Drewno brzozowe Birch wood Birkenholz		

Made in Europe

Z zastrzeżeniem zmian i możliwych błędów/Subject to changes and possible errors/Irtümer und Änderungen vorbehalten.

HEXAR



Przykładowa konfiguracja/Example configuration/Beispielkonfiguration



2) 7819176



1) 7819174

Dostępne konfiguracje/Available configurations/Verfügbare Konfigurationen



HEXAR

Wymiary Dimensions Maße	Lp. No. Lfd. Nr.	Nr art. Item No. Art.-Nr.	Kabel Cable Kabel	Kolor drewna Wood color Holzfarbe	Materiał Material Material	Oprawka Socket Fassung
	1	7819174	Czarny/Plastik Black/Synthetic Schwarz/Kunststoff	Dąb olejowany Oiled Oak Eiche geölt	Drewno dębowe Oak wood Eichenholz	1xE27 max. 25 W
	2	7819176		Orzech Walnut Nussbaum	Drewno bukowe Beech wood Buchenholz	
	3	7011174	Antracyt/W oplocie Dark grey/Braided Anthrazit/Geflochten	Dąb olejowany Oiled Oak Eiche geölt	Drewno dębowe Oak wood Eichenholz	
	4	7019176	Czarny/W oplocie Black/Braided Schwarz/Geflochten	Orzech Walnut Nussbaum	Drewno bukowe Beech wood Buchenholz	

Made in Europe

Z zastrzeżeniem zmian i możliwych błędów/Subject to changes and possible errors/Irtümer und Änderungen vorbehalten.

TRONGO



1) 7199174



3) 7191032



2) 7199176

Dostępne konfiguracje/Available configurations/Verfügbare Konfigurationen



TRONGO

Wymiary Dimensions Maße	Lp. No. Lfd. Nr.	Nr art. Item No. Art.-Nr.	Kabel Cable Kabel	Kolor - Color - Farbe		Materiał Material Material	Oprawka Socket Fassung
				Podstawa - Base - Basis	Abażur - Shade - Schirm		
	1	7199174	Czarny/Plastik Black/Synthetic Schwarz/Kunststoff	Dąb olejowany Oiled Oak Eiche geölt	Biały White Weiss	Drewno dębowe/Tkanina Oak wood/Fabric Eichenholz/Stoff	1xE27 max. 25 W
	2	7199176		Orzech Walnut Nussbaum		Drewno bukowe/Tkanina Beech wood/Fabric Buchenholz/Stoff	
	3	7191032	Transparentny/Plastik Transparent/Synthetic Transparent/Kunststoff	Dąb bielony Oak white Eiche Weiss		Drewno dębowe/Tkanina Oak wood/Fabric Eichenholz/Stoff	
	4	7191174	Antracyt/W oplocie Dark grey/Braided Anthrazit/Geflochten	Dąb olejowany Oiled Oak Eiche geölt		Drewno dębowe/Tkanina Oak wood/Fabric Eichenholz/Stoff	
	5	7191976	Czarny/W oplocie Black/Braided Schwarz/Geflochten	Orzech Walnut Nussbaum		Drewno bukowe/Tkanina Beech wood/Fabric Buchenholz/Stoff	
	6	7191432	Biało-czarny/W oplocie Black&White/Braided Schwarz-Weiss/Geflochten	Dąb bielony Oak white Eiche Weiss		Drewno dębowe/Tkanina Oak wood/Fabric Eichenholz/Stoff	

Made in Europe

Nr abażura/Shade No./Schirm-Nr.: A0322

Z zastrzeżeniem zmian i możliwych błędów/Subject to changes and possible errors/Irrtümer und Änderungen vorbehalten.

TRONGO



3) 7181032



2) 7181976

Przykładowa konfiguracja/Example configuration/Beispielkonfiguration



Dostępne konfiguracje/Available configurations/Verfügbare Konfigurationen



TRONGO

Wymiary Dimensions Maße	Lp. No. Lfd. Nr.	Nr art. Item No. Art.-Nr.	Kabel Cable Kabel	Kolor - Color - Farbe		Materiał Material Material	Oprawka Socket Fassung
				Podstawa - Base - Basis	Abażur - Shade - Schirm		
	1	7181974	Czarny/Plastik Black/Synthetic Schwarz/Kunststoff	Dąb olejowany Oiled Oak Eiche geölt	Biały White Weiss	Drewno dębowe/Tkanina Oak wood/Fabric Eichenholz/Stoff	1xE27 max. 25 W
	2	7181976		Orzech Walnut Nussbaum		Drewno bukowe/Tkanina Beech wood/Fabric Buchenholz/Stoff	
	3	7181032	Transparentny/Plastik Transparent/Synthetic Transparent/Kunststoff	Dąb bielony Oak white Eiche Weiss		Drewno dębowe/Tkanina Oak wood/Fabric Eichenholz/Stoff	
	4	7081174	Antracyt/W oplocie Dark grey/Braided Anthrazit/Geflochten	Dąb olejowany Oiled Oak Eiche geölt		Drewno dębowe/Tkanina Oak wood/Fabric Eichenholz/Stoff	
	5	7081976	Czarny/W oplocie Black/Braided Schwarz/Geflochten	Orzech Walnut Nussbaum		Drewno bukowe/Tkanina Beech wood/Fabric Buchenholz/Stoff	
	6	7081432	Biało-czarny/W oplocie Black&White/Braided Schwarz-Weiss/Geflochten	Dąb bielony Oak white Eiche Weiss		Drewno dębowe/Tkanina Oak wood/Fabric Eichenholz/Stoff	

Made in Europe

Nr abażura/Shade No./Schirm-Nr.: A0321

Z zastrzeżeniem zmian i możliwych błędów/Subject to changes and possible errors/Irrtümer und Änderungen vorbehalten.



1) 7179174



3) 7171032



5) 7171976

Dostępne konfiguracje/Available configurations/Verfügbare Konfigurationen



TRONGO Cube

Wymiary Dimensions Maße	Lp. No. Lfd. Nr.	Nr art. Item No. Art.-Nr.	Kabel Cable Kabel	Kolor drewna Wood color Holzfarbe	Materiał Material Material	Oprawka Socket Fassung
	1	7179174	Czarny/Tworzywo sztuczne Black/Synthetic Schwarz/Kunststoff	Dąb olejowany Oiled Oak Eiche geölt	Drewno dębowe Oak wood Eichenholz	1xE27 max. 25 W
	2	7179176		Orzech Walnut Nussbaum	Drewno bukowe Beech wood Buchenholz	
	3	7171032	Transparentny/Tworzywo sztuczne Transparent/Synthetic Transparent/Kunststoff	Dąb bielony Oak white Eiche Weiss	Drewno dębowe Oak wood Eichenholz	
	4	7171174	Antracyt/W oplocie Dark grey/Braided Anthrazit/Geflochten	Dąb olejowany Oiled Oak Eiche geölt	Drewno dębowe Oak wood Eichenholz	
	5	7171976	Czarny/W oplocie Black/Braided Schwarz/Geflochten	Orzech Walnut Nussbaum	Drewno bukowe Beech wood Buchenholz	
	6	7171432	Biało-czarny/W oplocie Black&White/Braided Schwarz-Weiss/Geflochten	Dąb bielony Oak white Eiche Weiss	Drewno dębowe Oak wood Eichenholz	

Made in Europe

Z zastrzeżeniem zmian i możliwych błędów/Subject to changes and possible errors/Irtümer und Änderungen vorbehalten.

TRONGO



1) 7079174



3) 7071032



5) 7071976

Dostępne konfiguracje/Available configurations/Verfügbare Konfigurationen



TRONGO Round

Wymiary Dimensions Maße	Lp. No. Lfd. Nr.	Nr art. Item No. Art.-Nr.	Kabel Cable Kabel	Kolor Color Farbe	Materiał Material Material	Oprawka Socket Fassung
	1	7079174	Czarny/Tworzywo sztuczne Black/Synthetic Schwarz/Kunststoff	Dąb olejowany Oiled Oak Eiche geölt	Drewno dębowe Oak wood Eichenholz	1xE27 max. 25 W
	2	7079176		Orzech Walnut Nussbaum	Drewno bukowe Beech wood Buchenholz	
	3	7071032	Transparentny/Tworzywo sztuczne Transparent/Synthetic Transparent/Kunststoff	Dąb bielony Oak white Eiche Weiss	Drewno dębowe Oak wood Eichenholz	
	4	7071174	Antracyt/W oplocie Dark grey/Braided Anthrazit/Geflochten	Dąb olejowany Oiled Oak Eiche geölt	Drewno dębowe Oak wood Eichenholz	
	5	7071976	Czarny/W oplocie Black/Braided Schwarz/Geflochten	Orzech Walnut Nussbaum	Drewno bukowe Beech wood Buchenholz	
	6	7071432	Biało-czarny/W oplocie Black&White/Braided Schwarz-Weiss/Geflochten	Dąb bielony Oak white Eiche Weiss	Drewno dębowe Oak wood Eichenholz	

Made in Europe

Z zastrzeżeniem zmian i możliwych błędów/Subject to changes and possible errors/Irtümer und Änderungen vorbehalten.

SANDY

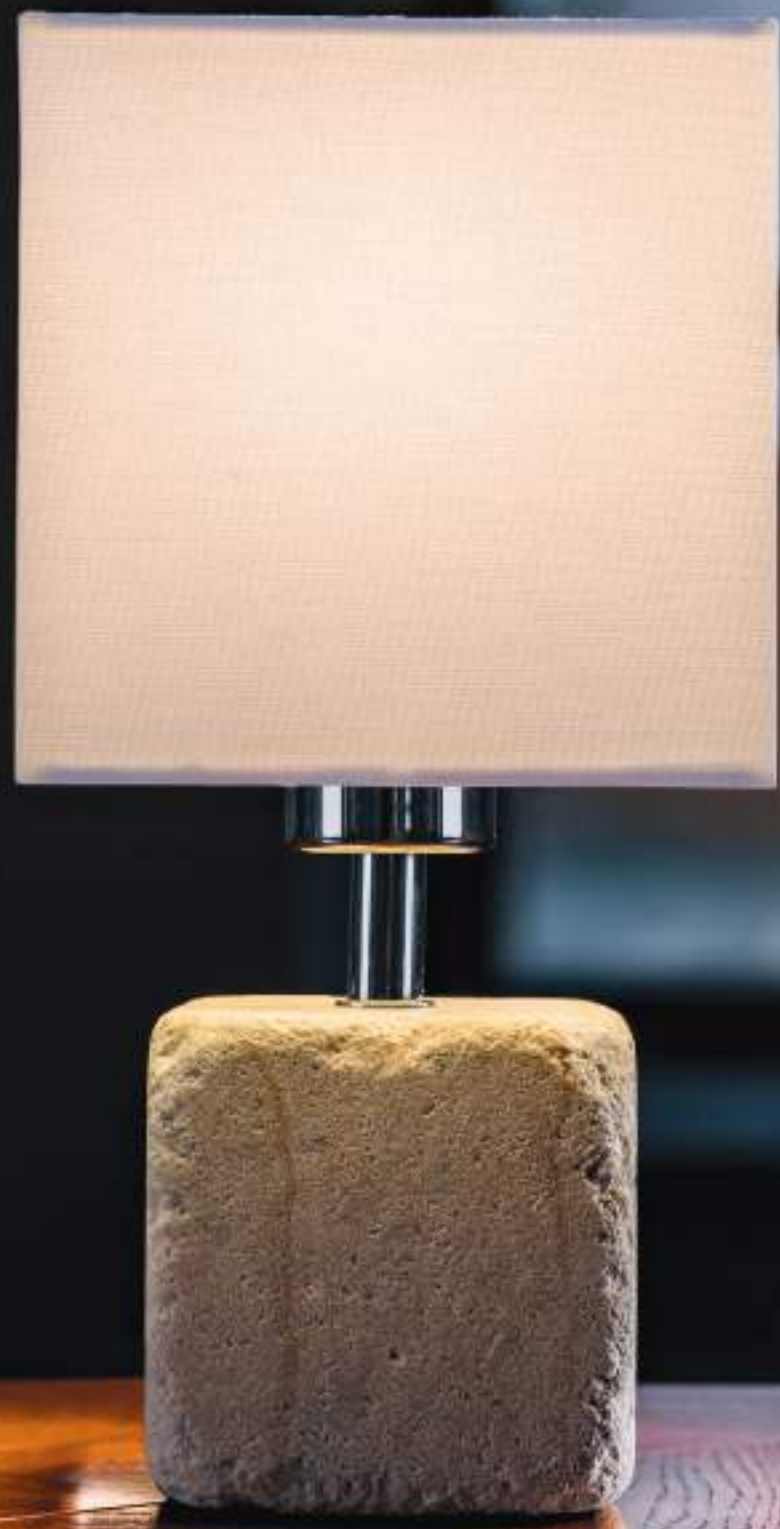

2) 7091039



1) 7090039

Dostępne konfiguracje/Available configurations/Verfügbare Konfigurationen

SANDY

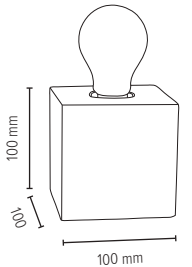
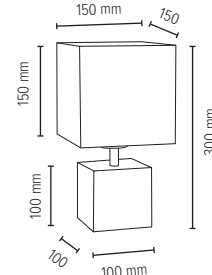
Wymiary Dimensions Maße	Lp. No. Lfd. Nr.	Nr art. Item No. Art.-Nr.	Materiał Material Material	Kolor abażura Shade color Schirmfarbe	Kolor kabla Cable color Kabelfarbe	Oprawka Socket Fassung
	1	7090039	Piaskowiec Sandstone Sandstein	---	Transparentny Transparent Transparent	1xE27 max. 25 W
	2	7091039	Piaskowiec/Tkanina Sandstone/Fabric Sandstein/Stoff	Biały White Weiss		

Made in Europe

Nr abażura/Shade No./Schirm-Nr.: A0322

Z zastrzeżeniem zmian i możliwych błędów/Subject to changes and possible errors/Irrtümer und Änderungen vorbehalten.

BETON

Ten naturalny materiał jest niezwykle wszechstronny - mocny i trwały a jednocześnie pozwalający się formować na wiele kształtów. Elementy betonowe, które wykorzystujemy do budowy naszych opraw oświetleniowych, zostały wykonane ze specjalnie skomponowanej dla nas mieszanki zawierającej między innymi, różnego rodzaju cementy, pigmenty, polimery oraz włókno szklane. Sprawiają one, że nasz produkt jest wytrzymały, odporny na pęknięcia oraz nieszkodliwy dla użytkowników i środowiska. Odlewy betonowe nie powstają na linii produkcyjnej - są wykonywane ręcznie przez naszego lokalnego dostawcę. Dzięki temu możemy w sposób ciągły nadzorować proces produkcji a tym samym zadbać o wysoką jakość i powtarzalność parametrów poszczególnych dostaw. Lampy z betonu idealnie wpasowują się w trend industrialny i minimalistyczny w wystroju wnętrz, świetnie łączą się z innymi naturalnymi materiałami, jak drewno, kamień czy cegła.

This natural material is extremely versatile - strong, durable and, despite its robust properties, it can be flexibly shaped. The concrete elements from which we build our luminaires are made from a specially developed blend that contains various types of cements, pigments, polymers and glass fibers. They make our product durable, crack resistant and safe for users and the environment. Concrete casts are not produced on the production line - they are handmade by our local supplier. This allows us to continuously monitor the production process, ensuring high quality and reproducibility of individual deliveries. Concrete lamps fit perfectly into the industrial and minimalist interior design trend and blend perfectly with other natural materials such as wood, stone or brick.

Dieses natürliche Material ist äußerst vielseitig – stark, langlebig und trotz robuster Eigenschaften lässt es sich flexibel in Form bringen. Die Betonelemente, aus denen wir unsere Leuchten bauen, wurden aus einer speziell für uns entwickelten Mischung gefertigt, die unter anderem verschiedene Arten von Zementen, Pigmente, Polymere und Glasfasern enthält. Sie machen unser Produkt beständig, rissfest und unbedenklich für Anwender und Umwelt. Betonabgüsse werden nicht auf der Produktionslinie hergestellt - sie werden von unserem lokalen Lieferanten handgefertigt. Dadurch können wir den Produktionsprozess kontinuierlich überwachen und so eine hohe Qualität und Reproduzierbarkeit der einzelnen Lieferungen gewährleisten. Betonlampen fügen sich perfekt in den industriellen und minimalistischen Trend der Innenarchitektur ein und lassen sich perfekt mit anderen natürlichen Materialien wie Holz, Stein oder Ziegel kombinieren.

B

E

T



O



N

FORTAN



1) 8254136



2) 8254236



3) 8254336



4) 8254436

Dostępne konfiguracje/Available configurations/Verfügbare Konfigurationen

FORTAN

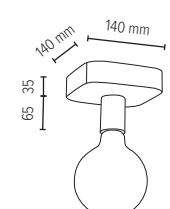
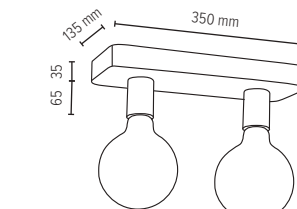
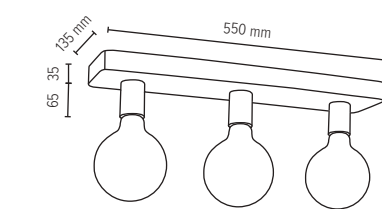
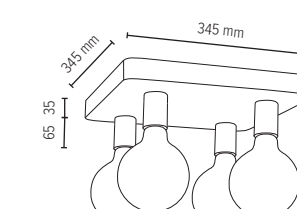
Wymiary Dimensions Maße	Lp. No. Lfd. Nr.	Nr art. Item No. Art.-Nr.	Kolor Color Farbe	Materiał Material Material	Oprawka Socket Fassung
	1	8254136	Szary/Czarny Grey/Black Grau/Schwarz	Beton/Metal Concrete/Metal Beton/Metall	1xE27 max. 60 W
	2	8254236			2xE27 max. 60 W
	3	8254336			3xE27 max. 60 W
	4	8254436			4xE27 max. 60 W

Made in Europe

Z zastrzeżeniem zmian i możliwych błędów/Subject to changes and possible errors/Irtümer und Änderungen vorbehalten.

STRONG



4) 6070937



3) 6070936



2) 6170937



1) 6170936

Dostępne konfiguracje/Available configurations/Verfügbare Konfigurationen

STRONG

Wymiary Dimensions Maße	Lp. No. Lfd. Nr.	Nr art. Item No. Art.-Nr.	Kolor - Color - Farbe		Materiał Material Material	Oprawka Socket Fassung
			Podstawa - Base - Basis	Kabel - Cable - Kabel		
	1	6170936	Szary Grey Grau	Czarny Black Schwarz	Beton Concrete Beton	1xE27 max. 25 W
	2	6170937	Biały White Weiss			
	3	6070936	Szary Grey Grau			
	4	6070937	Biały White Weiss			

Made in Europe

Z zastrzeżeniem zmian i możliwych błędów/Subject to changes and possible errors/Irrtümer und Änderungen vorbehalten.

STRONG



1) 6191936



2) 6191937



1) 6091936



2) 6091937

Dostępne konfiguracje/Available configurations/Verfügbare Konfigurationen

STRONG

Wymiary Dimensions Maße	Lp. No. Lfd. Nr.	Nr art. Item No. Art.-Nr.	Kolor - Color - Farbe			Materiał Material Material	Oprawka Socket Fassung
			Podstawa - Base - Basis	Abażur - Shade - Schirm	Kabel - Cable - Kabel		
	1	6191936	Szary Grey Grau	Biały White Weiss	Czarny Black Schwarz	Beton/Tkanina Concrete/Fabric Beton/Stoff	1xE27 max. 25 W
	2	6191937	Biały White Weiss				
	3	6091936	Szary Grey Grau				
	4	6091937	Biały White Weiss				

Made in Europe

Nr abażura/Shade No./Schirm-Nr.: A0322 (pos. 1,2), A0321 (pos. 3,4)

Z zastrzeżeniem zmian i możliwych błędów/Subject to changes and possible errors/Irrtümer und Änderungen vorbehalten.

STRONG DOUBLE



1) 7370936



2) 7370937

Dostępne konfiguracje/Available configurations/Verfügbare Konfigurationen

STRONG DOUBLE

Wymiary Dimensions Maße	Lp. No. Lfd. Nr.	Nr art. Item No. Art.-Nr.	Kolor - Color - Farbe		Materiał Material Material	Oprawka Socket Fassung
			Podstawa - Base - Basis	Kabel - Cable - Kabel		
	1	7370936	Szary Grey Grau	Czarny Black Schwarz	Beton Concrete Beton	1xE27 max. 25 W
	2	7370937	Biały White Weiss			

Made in Europe

Z zastrzeżeniem zmian i możliwych błędów/Subject to changes and possible errors/Irtümer und Änderungen vorbehalten.

STRONG DOUBLE



1) 7381936



2) 7381937

Dostępne konfiguracje/Available configurations/Verfügbare Konfigurationen

STRONG DOUBLE

Wymiary Dimensions Maße	Lp. No. Lfd. Nr.	Nr art. Item No. Art.-Nr.	Kolor - Color - Farbe			Materiał Material Material	Oprawka Socket Fassung
			Podstawa - Base - Basis	Abażur - Shade - Schirm	Kabel - Cable - Kabel		
	1	7381936	Szary Grey Grau	Biały White Weiss	Czarny Black Schwarz	Beton/Tkanina Concrete/Fabric Beton/Stoff	1xE27 max. 25 W
	2	7381937	Biały White Weiss				

Made in Europe

Nr abażura/Shade No./Schirm-Nr.: A1032

Z zastrzeżeniem zmian i możliwych błędów/Subject to changes and possible errors/Irtümer und Änderungen vorbehalten.

BLOCK



1) 2255136



2) 2255137



1) 8973236



2) 8973237

Dostępne konfiguracje/Available configurations/Verfügbare Konfigurationen

BLOCK

Wymiary Dimensions Maße	Lp. No. Lfd. Nr.	Nr art. Item No. Art.-Nr.	Kolor Color Farbe	Materiał Material Material	Oprawka Socket Fassung
	1	2255136	Szary Grey Grau	Beton Concrete Beton	1xG9 max. 28 W
	2	2255137	Biały White Weiss		
	3	8973236	Szary Grey Grau		2xGU10 max. 6 W
	4	8973237	Biały White Weiss		

Made in Europe

Z zastrzeżeniem zmian i możliwych błędów/Subject to changes and possible errors/Irrtümer und Änderungen vorbehalten.

BLOCK



2) 8971137



3) 8972136



4) 8972137

Przykładowa konfiguracja/Example configuration/Beispielkonfiguration

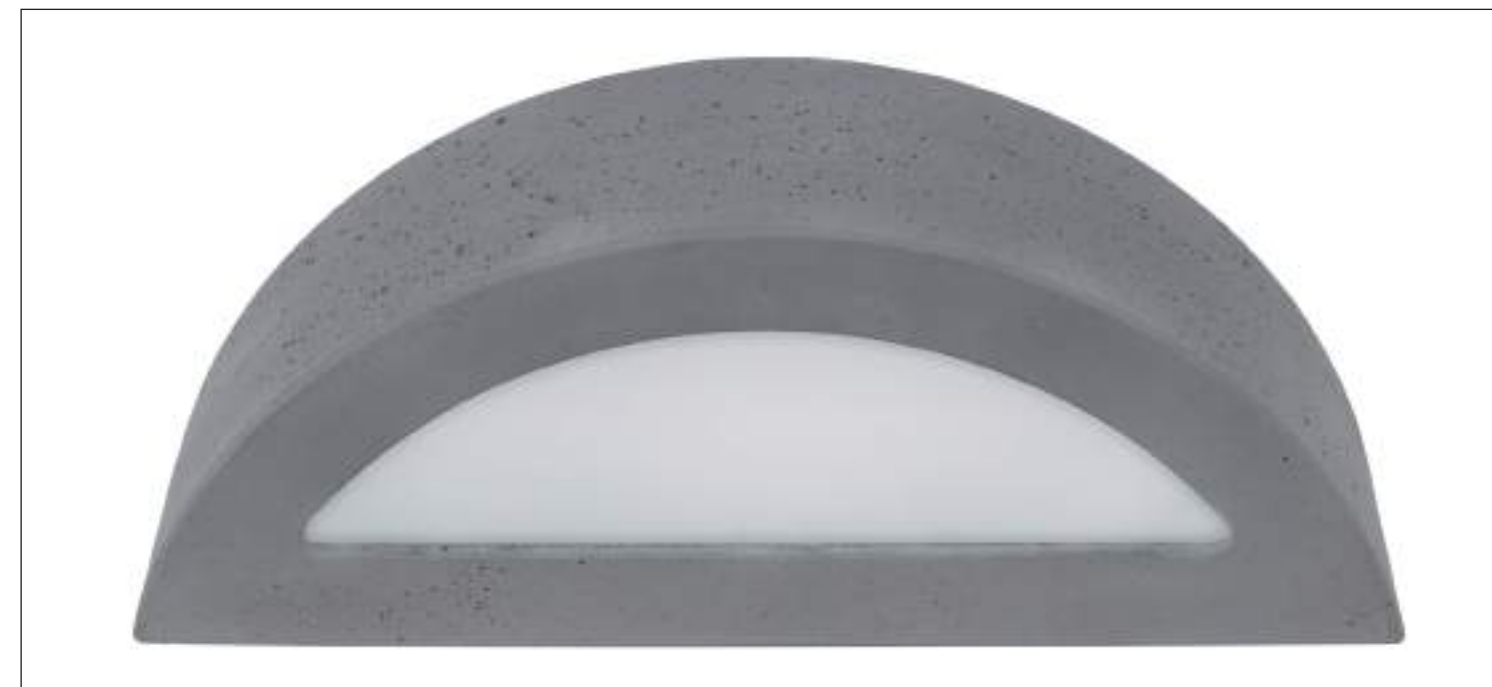

Dostępne konfiguracje/Available configurations/Verfügbare Konfigurationen

BLOCK

Wymiary Dimensions Maße	Lp. No. Lfd. Nr.	Nr art. Item No. Art.-Nr.	Kolor Color Farbe	Materiał Material Material	Oprawka Socket Fassung
	1	8971136	Szary/Szroniony Grey/Frosted Grau/Milchglas	Beton/Szkło Concrete/Glass Beton/Glas	1xE27 max. 40 W
	2	8971137	Biały/Szroniony White/Frosted Weiss/Milchglas		
	3	8972136	Szary/Szroniony Grey/Frosted Grau/Milchglas		
	4	8972137	Biały/Szroniony White/Frosted Weiss/Milchglas		

Made in Europe

Z zastrzeżeniem zmian i możliwych błędów/Subject to changes and possible errors/Irrtümer und Änderungen vorbehalten.

STRONG



2) 7169336R



3) 7169336L

Przykładowa konfiguracja/Example configuration/Beispielkonfiguration

Dostępne konfiguracje/Available configurations/Verfügbare Konfigurationen

STRONG

Wymiary Dimensions Maße	Lp. No. Lfd. Nr.	Nr art. Item No. Art.-Nr.	Kolor Color Farbe	Materiał Material Material	Kolor Kabla Cable Color Kabelfarbe	Oprawka Socket Fassung
	1	7061936				1xE27 max. 60 W
	2	7169336R	Szary Grey Grau	Beton Concrete Beton	Czarny/W oplocie Black/Braided Schwarz/Geflochten	3xE27 max. 60 W
	3	7169336L				3xE27 max. 60 W

Made in Europe

Z zastrzeżeniem zmian i możliwych błędów/Subject to changes and possible errors/Irrtümer und Änderungen vorbehalten.

STRONG



2) 7089336



3) 7089436

Przykładowa konfiguracja/Example configuration/Beispielkonfiguration

Dostępne konfiguracje/Available configurations/Verfügbare Konfigurationen

STRONG

Wymiary Dimensions Maße	Lp. No. Lfd. Nr.	Nr art. Item No. Art.-Nr.	Kolor Color Farbe	Materiał Material Material	Kolor Kabla Cable Color Kabelfarbe	Oprawka Socket Fassung
	1	7089136				1xE27 max. 60 W
	2	7089336	Szary Grey Grau	Beton Concrete Beton	Czarny/W oplocie Black/Braided Schwarz/Geflochten	3xE27 max. 60 W
	3	7089436				4xE27 max. 60 W

Made in Europe

Z zastrzeżeniem zmian i możliwych błędów/Subject to changes and possible errors/Irrtümer und Änderungen vorbehalten.

AMORY



3) 9774136

Przykładowa konfiguracja/Example configuration/Beispielkonfiguration



2) 9776136

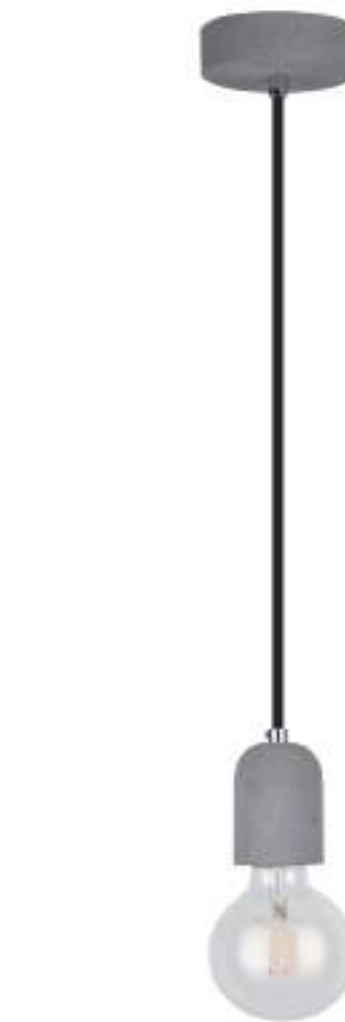

1) 9779136

Przykładowa konfiguracja/Example configuration/Beispielkonfiguration



AMORY



4) 9779336R



5) 9776336R

Przykładowa konfiguracja/Example configuration/Beispielkonfiguration

Dostępne konfiguracje/Available configurations/Verfügbare Konfigurationen

AMORY

Wymiary Dimensions Maße	Lp. No. Lfd. Nr.	Nr art. Item No. Art.-Nr.	Kolor Kabla Cable Color Kabelfarbe	Materiał Material Material	Kolor Color Farbe	Oprawka Socket Fassung		
	1	9779136	Czarny - Black - Schwarz	Beton Concrete Beton	Szary Grey Grau	1xE27 max. 60 W		
	2	9776136	Czerwony - Red - Rot					
	3	9774136	Biało-czarny - Black&White Schwarz-Weiß					
	4	9779336R	Czarny - Black - Schwarz			Beton Concrete Beton	Szary Grey Grau	3xE27 max. 60 W
	5	9776336R	Czerwony - Red - Rot					
	6	9774336R	Biało-czarny - Black&White Schwarz-Weiß					

Made in Europe

Z zastrzeżeniem zmian i możliwych błędów/Subject to changes and possible errors/Irrtümer und Änderungen vorbehalten.

KARLA

Dostępne konfiguracje/Available configurations/Verfügbare Konfigurationen



1) 9160136



3) 9160336



2) 9160336R

KARLA							
Wymiary Dimensions Maße	Lp. No. Lfd. Nr.	Nr art. Item No. Art.-Nr.	Kolor - Color - Farbe			Materiał Material Material	Oprawka Socket Fassung
			Podstawa - Base - Basis	Szkoło - Glass - Glas	Kabel - Cable - Kabel		
	1	9160136					1xE27 max. 60 W
	2	9160336R	Szary Grey Grau	Biały White Weiss	Transparentny Transparent Transparent	Beton/Szkoło Concrete/Glass Beton/Glas	3xE27 max. 60 W
	3	9160336					3xE27 max. 60 W

Made in Europe

Nr szkła - Glass No. - Glas-Nr. G0770

Z zastrzeżeniem zmian i możliwych błędów/Subject to changes and possible errors/Irtümer und Änderungen vorbehalten.

MADE IN EU

Nasze oprawy oświetleniowe powstają w Europie, w zakładzie produkcyjnym SPOT Light w Bierawie, na południu Polski. Zespół wykwalifikowanych 180 pracowników tworzy produkty najwyższej jakości korzystając z bogatej tradycji europejskiego rzemiosła. Materiały i komponenty używane do produkcji, jak: certyfikowane drewno, odlewy betonowe, szkło, abażury czy części metalowe pochodzą od najlepszych polskich, niemieckich i włoskich dostawców. Produkcja w Europie jest nie tylko gwarancją najwyższej jakości i innowacyjności, oznacza również krótkie drogi transportu, które umożliwiają skrócenie terminu dostaw, zamawianie małych ilości oraz zmniejszenie emisji substancji szkodliwych dla środowiska. Równie ważnym aspektem jest odpowiedzialność społeczna - kupując produkty europejskie, promujesz lokalne zatrudnienie i godne warunki pracy dla personelu produkcyjnego.

Our lighting fixtures are made in Europe, manufactured in SPOT Light's production facilities in Bierawa in the south of Poland. A team of 180 qualified employees creates the highest quality products drawing on the tradition of the European craftsmanship. Materials and components used for production, such as certified wood, concrete castings, glass, lampshades and metal parts come from the best Polish, German and Italian suppliers. Production in Europe not only guarantees the highest quality and innovation, but also means short transport routes, that enable faster delivery times and lower order quantities. Thanks to a well-organized transport with short distances, we can significantly reduce our ecological footprint. Equally important is social responsibility - by buying European products you provide jobs to the local community and ensure good working conditions for production staff.

Unsere Leuchten werden in Europa hergestellt, in Produktionsstätte von SPOT Light im südpolnischen Bierawa. Ein Team von 180 qualifizierten Mitarbeitern kreiert Produkte von höchster Qualität anhand von der reichen Tradition der europäischen Handwerkskunst. Die für Produktion verwendete Materialien und Komponenten, wie zertifiziertes Holz, Beton, Glas, Lampenschirme und Metallteile stammen von den besten polnischen, deutschen und italienischen Lieferanten. Die Produktion in Europa ist nicht nur ein Garant für höchste Qualität und Innovation, sondern bedeutet auch kurze Transportwege, die schnellere Lieferzeiten und geringere Bestellmengen ermöglichen. Dank einem gut organisierten Transport mit geringen Entfernungen, können wir unseren ökologischen Fußabdruck erheblich reduzieren. Ebenso wichtig ist die soziale Verantwortung: Durch den Kauf europäischer Produkte fördern Sie die Beschäftigung vor Ort und menschenwürdige Arbeitsbedingungen für das Produktionspersonal.

**SPOT
LIGHT**

**SPOT
LIGHT**

**SPOT
LIGHT**



E

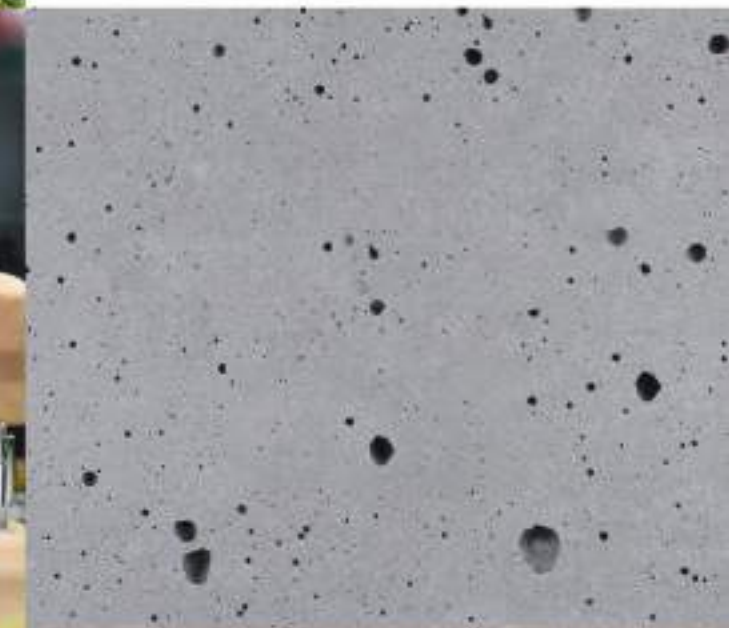

U

FRESH



2) 1860136



1) 1860128



4) 1860336R



Dostępne konfiguracje/Available configurations/Verfügbare Konfigurationen

FRESH

Wymiary Dimensions Maße	Lp. No. Lfd. Nr.	Nr art. Item No. Art.-Nr.	Kolor - Color - Farbe			Materiał Material Material	Oprawka Socket Fassung
			Podstawa - Base - Basis	Szkoło - Glass - Glas	Kabel - Cable - Kabel		
	1	1860128	Chrom Chrome Chrom	Szronione-Transparentne Frosted-Transparent Milchglas-Transparent	Transparentny Transparent Transparent	Metal/Szkoło Metal/Glass Metall/Glas	1xE27 max. 60 W
	2	1860136	Szary Grey Grau				
	3	1860328R	Chrom Chrome Chrom			Metal/Szkoło Metal/Glass Metall/Glas	3xE27 max. 60 W
	4	1860336R	Szary Grey Grau				

Made in Europe

Nr szkła - Glass No. - Glas-Nr. G1545

Z zastrzeżeniem zmian i możliwych błędów/Subject to changes and possible errors/Irrtümer und Änderungen vorbehalten.

GREAT



1) 2241136



2) 2241236



3) 2241336

Przykładowa konfiguracja/Example configuration/Beispielkonfiguration

Dostępne konfiguracje/Available configurations/Verfügbare Konfigurationen

GREAT

Wymiary Dimensions Maße	Lp. No. Lfd. Nr.	Nr art. Item No. Art.-Nr.	Kolor - Color - Farbe		Materiał Material Material	Oprawka Socket Fassung
			Podstawa - Base - Basis	Abażur - Shade - Schirm		
	1	2241136				1xE27 max. 25 W
	2	2241236				2xE27 max. 25 W
	3	2241336	Szary Grey Grau	Biały White Weiss	Beton/Tkanina Concrete/Fabric Beton/Stoff	3xE27 max. 25 W
	4	2241436				4xE27 max. 25 W
	5	7511936				1xE27 max. 25 W

Made in Europe

Nr abażura - Shade No. - Schirm-Nr. A0994

Z zastrzeżeniem zmian i możliwych błędów/Subject to changes and possible errors/Irrtümer und Änderungen vorbehalten.

GENTLE



1) 2321136



2) 2321236



3) 2321336



4) 2321436

Przykładowa konfiguracja/Example configuration/Beispielkonfiguration

Dostępne konfiguracje/Available configurations/Verfügbare Konfigurationen

GENTLE

Wymiary Dimensions Maße	Lp. No. Lfd. Nr.	Nr art. Item No. Art.-Nr.	Kolor - Color - Farbe		Materiał Material Material	Oprawka Socket Fassung
			Podstawa - Base - Basis	Abażur - Shade - Schirm		
	1	2321136	Szary Grey Grau	Biały White Weiss	Beton/Tkanina Concrete/Fabric Beton/Stoff	1xE27 max. 25 W
	2	2321236				2xE27 max. 25 W
	3	2321336				3xE27 max. 25 W
	4	2321436				4xE27 max. 25 W
	5	7411936				1xE27 max. 25 W

Made in Europe

Nr abażura/Shade No./Schirm-Nr.: A0722

Z zastrzeżeniem zmian i możliwych błędów/Subject to changes and possible errors/Irrtümer und Änderungen vorbehalten.



2) 8172236



4) 8172436

Przykładowa konfiguracja/Example configuration/Beispielkonfiguration

Dostępne konfiguracje/Available configurations/Verfügbare Konfigurationen

GITTAN						
Wymiary Dimensions Maße	Lp. No. Lfd. Nr.	Nr art. Item No. Art.-Nr.	Kolor - Color - Farbe		Materiał Material Material	Oprawka Socket Fassung
			Podstawa - Base - Basis	Klosz - Shade - Schirm		
	1	8172136	Szary Grey Grau	Chrom Chrome Chrom	Beton/Metal Concrete/Metal Beton/Metall	1xE27 max. 60 W
	2	8172236				2xE27 max. 60 W
	3	8172336				3xE27 max. 60 W
	4	8172436				4xE27 max. 60 W
Made in Europe						Nr klosza - Shade No. - Schirm Nr. G0598

Z zastrzeżeniem zmian i możliwych błędów/Subject to changes and possible errors/Irtümer und Änderungen vorbehalten.

BALL CONCRETE



1) 5131136



2) 5131236



3) 5131336



4) 5131436

Dostępne konfiguracje/Available configurations/Verfügbare Konfigurationen

BALL CONCRETE

Wymiary Dimensions Maße	Lp. No. Lfd. Nr.	Nr art. Item No. Art.-Nr.	Kolor - Color - Farbe		Materiał Material Material	Oprawka Socket Fassung
			Podstawa - Base - Basis	Klosz - Head - Kopf		
	1	5131136	Szary Grey Grau	Satyna Satin Satin	Beton/Metal Concrete/Metal Beton/Metall	Incl. 1xLED GU10 5 W 320 lm, 2700 K, Ra>90
	2	5131236				Incl. 2xLED GU10 5 W 320 lm, 2700 K, Ra>90
	3	5131336				Incl. 3xLED GU10 5 W 320 lm, 2700 K, Ra>90
	4	5131436				Incl. 4xLED GU10 5 W 320 lm, 2700 K, Ra>90

Made in Europe

Z zastrzeżeniem zmian i możliwych błędów/Subject to changes and possible errors/Irrtümer und Änderungen vorbehalten.

COOL



1) 2291136



3) 2291236



2) 2291137



4) 2291237

Przykładowa konfiguracja/Example configuration/Beispielkonfiguration

COOL



5) 2291336



7) 2291436



6) 2291337



8) 2291437

Dostępne konfiguracje/Available configurations/Verfügbare Konfigurationen

COOL

Wymiary Dimensions Maße	Lp. No. Lfd. Nr.	Nr art. Item No. Art.-Nr.	Kolor Color Farbe	Materiał Material Material	Źródło światła Light source Lichtquelle
	1	2291136	Szary/Satyna Grey/Satin Grau/Satin	Beton/Metal Concrete/Metal Beton/Metall	Incl. 1xLED 5 W 300 lm, 3000 K
	2	2291137	Biały/Satyna White/Satin Weiss/Satin		
	3	2291236	Szary/Satyna Grey/Satin Grau/Satin		Incl. 2xLED 5 W 300 lm, 3000 K
	4	2291237	Biały/Satyna White/Satin Weiss/Satin		
	5	2291336	Szary/Satyna Grey/Satin Grau/Satin		Incl. 3xLED 5 W 300 lm, 3000 K
	6	2291337	Biały/Satyna White/Satin Weiss/Satin		
	7	2291436	Szary/Satyna Grey/Satin Grau/Satin		Incl. 4xLED 5 W 300 lm, 3000 K
	8	2291437	Biały/Satyna White/Satin Weiss/Satin		

Made in Europe

Z zastrzeżeniem zmian i możliwych błędów/Subject to changes and possible errors/Irrtümer und Änderungen vorbehalten.

Przykładowa konfiguracja/Example configuration/Beispielkonfiguration

ROCKY



3) 4754036



1) 4753036

Przykładowa konfiguracja/Example configuration/Beispielkonfiguration



Dostępne konfiguracje/Available configurations/Verfügbare Konfigurationen

ROCKY

Wymiary Dimensions Maße	Lp. No. Lfd. Nr.	Nr art. Item No. Art.-Nr.	Źródło światła Light source Lichtquelle	Kolor - Color - Farbe		Materiał Material Material
				Podstawa - Base - Basis	Szkoło - Glass - Glas	
	1	4753036	zintegrowane - integrated - integriert 1xLED 13 W 1200 lm, 2700 K	Szary Grey Grau	Biały White Weiss	Beton/Szkoło Concrete/Glas Beton/Glas
	2	4753236	2xE27 max. 40 W			
	3	4754036	zintegrowane - integrated - integriert 1xLED 18W 1650 lm, 2700 K			
	4	4754236	3xE27 max. 40 W			

Made in Europe

Nr szkła - Glass No. - Glas-Nr. G0651 (Ø300mm), G0652 (Ø400mm)

Z zastrzeżeniem zmian i możliwych błędów/Subject to changes and possible errors/Irrtümer und Änderungen vorbehalten.

JOSEFINA



1) 4762802



9) 4783802



14) 4794802



Mocowanie abażura na magnes
Lamp shade fixed to magnets
Lampenschirm befestigt an Magneten



Dostępne konfiguracje/Available configurations/Verfügbare Konfigurationen

JOSEFINA

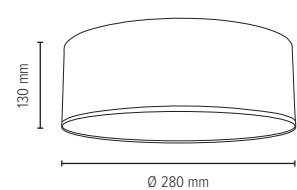
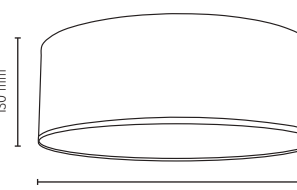
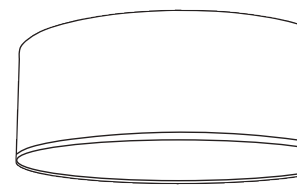
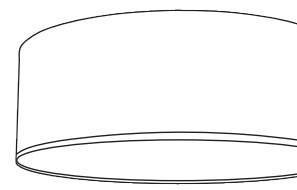
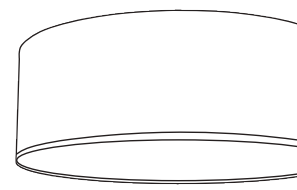
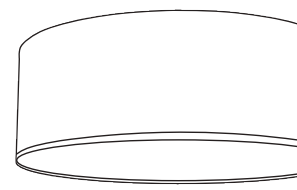
Wymiary Dimensions Maße	Lp. No. Lfd. Nr.	Nr art. Item No. Art.-Nr.	Źródło światła Light source Lichtquelle	Kolor - Color - Farbe		Materiał Material Material	
				Abażur - Shade - Schirm	Blenda - Cover - Blende		
 <p>130 mm Ø 280 mm</p>	1	4762802	zintegrowane - integrated integriert 1xLED 13 W 1200 lm, 2700 K	Biały - White - Weiss	Biały White Weiss	Tkanina/Akryl Fabric/Acrylic Stoff/Acryl	
	2	4792802		Brązowy - Brown - Braun			
	3	4782802		Antracyt - Dark grey - Anthrazit			
	 <p>130 mm Ø 380 mm</p>	4	4762812	2xE27 max. 25 W			Biały - White - Weiss
		5	4792812				Brązowy - Brown - Braun
		6	4782812				Antracyt - Dark grey - Anthrazit
 <p>130 mm Ø 480 mm</p>		7	4763802	zintegrowane - integrated integriert 1xLED 18 W 1650 lm, 2700 K			Biały - White - Weiss
		8	4793802				Brązowy - Brown - Braun
		9	4783802				Antracyt - Dark grey - Anthrazit
	 <p>130 mm Ø 480 mm</p>	10	4763812	3xE27 max. 25 W			Biały - White - Weiss
		11	4793812				Brązowy - Brown - Braun
		12	4783812				Antracyt - Dark grey - Anthrazit
 <p>130 mm Ø 480 mm</p>		13	4764802	zintegrowane - integrated integriert 1xLED 30 W 2600 lm, 2700 K			Biały - White - Weiss
		14	4794802				Brązowy - Brown - Braun
		15	4784802				Antracyt - Dark grey - Anthrazit
	 <p>130 mm Ø 480 mm</p>	16	4764812	4xE27 max. 25 W			Biały - White - Weiss
		17	4794812				Brązowy - Brown - Braun
		18	4784812				Antracyt - Dark grey - Anthrazit

Made in Europe

Nr abażura/Shade No./Schirm-Nr.: Strona/Page/Seite: 315-316.

Przykładowa konfiguracja/Example configuration/Beispielkonfiguration

Z zastrzeżeniem zmian i możliwych błędów/Subject to changes and possible errors/Irrtümer und Änderungen vorbehalten.

JOSEFINA



3) 57850127



2) 57950127

Przykładowa konfiguracja/Example configuration/Beispielkonfiguration



Dostępne konfiguracje/Available configurations/Verfügbare Konfigurationen

JOSEFINA

Wymiary Dimensions Maße	Lp. No. Lfd. Nr.	Nr art. Item No. Art.-Nr.	Kolor - Color - Farbe			Materiał Material Material	Oprawka Socket Fassung
			Abażur - Shade Schirm	Blenda - Cover Blende	Podsufitka - Canopy Baldachin		
	1	57650127	Biały - White - Weiss	Biały White Weiss	Satyna Satin Satin	Tkanina/Akryl/Metal Fabric/Acrylic/Metal Stoff/Acryl/Metall	3xE27 max. 25 W
	2	57950127	Brązowy - Brown - Braun				
	3	57850127	Antracyt - Dark grey - Anthrazit				

Made in Europe

Nr abażura/Shade No./Schirm-Nr.: Strona/Page/Seite: 316.

Z zastrzeżeniem zmian i możliwych błędów/Subject to changes and possible errors/Irrtümer und Änderungen vorbehalten.

SHADE

Nasza nowa kolekcja Basic zawiera wiele modeli z ciekawymi abażurami. Klasyczne stożki i walce z tkanin w stonowanych kolorach pasują do większości aranżacji nadając im przytulnego charakteru. Abażury z modnego aksamitu z serii Scarlett, od wewnątrz wykończone elegancką tkaniną, wyróżniają się perfekcyjnym wykonaniem i ciekawą kolorystyką. Z kolei modele Leila z tłoczonego papieru naprawdę ożywają dopiero po zapaleniu światła, które to podkreśla ich wyjątkową strukturę. Wszystkie abażury z naszej kolekcji Basic zostały wyprodukowane w Polsce z dużą starannością i dbałością o detal. Tkaniny i materiały użyte do produkcji abażurów są najwyższej jakości, pochodzą od największych polskich i europejskich producentów.

Our new Basic Collection contains many models with interesting lampshades. Classic cone and cylinder shaped shades made of fabrics in muted colors match most arrangements, giving them a cozy character. Scarlett series made of fashionable velvet, finished with elegant fabric on the shade inside, stands out by perfect craftsmanship and vibrant colors. On the other hand, Leila models made of embossed paper really come to life only after switching on the light, which emphasizes their unique structure. All lampshades from our Basic collection were manufactured in Poland with great care and attention to detail. Fabrics and materials used for the production of our lampshades are the highest quality, they come from the largest Polish and European producers.

Unsere neue Basic-Kollektion umfasst viele Modelle mit interessanten Lampenschirmen. Klassische runde und konische Schirme aus Stoffen in gedeckten Farben passen zu den meisten Arrangements und verleihen ihnen einen gemütlichen Charakter. Die Scarlett-Serie aus modischem Samt mit elegantem Stoff auf der Innenseite zeichnet sich durch perfekte Verarbeitung und lebendige Farben aus. Auf der anderen Seite werden Leila-Modelle aus geprägtem Papier erst nach dem Einschalten des Lichts zum Leben erweckt, was ihre einzigartige Struktur unterstreicht. Alle Lampenschirme aus unserer Basic-Kollektion wurden in Polen mit größter Sorgfalt und Liebe zum Detail hergestellt. Stoffe und Materialien, die für die Herstellung von Lampenschirmen verwendet werden, sind von höchster Qualität; sie stammen von den größten polnischen und europäischen Herstellern.



S



H



A



D

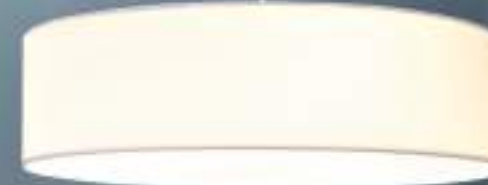

E

SCARLETT



8) 6745027

Przykładowa konfiguracja/Example configuration/Beispielkonfiguration



5) 6741027

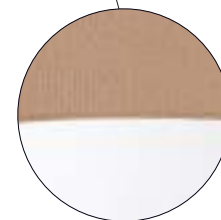

Tkanina w środku
Fabric inside
Stoff innen



6) 6742027

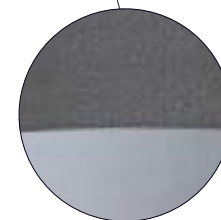

Tkanina w środku
Fabric inside
Stoff innen



7) 6744027



Tkanina w środku
Fabric inside
Stoff innen

SCARLETT



9) 7751027



11) 7754027

Przykładowa konfiguracja/Example configuration/Beispielkonfiguration

Dostępne konfiguracje/Available configurations/Verfügbare Konfigurationen

SCARLETT

Wymiary Dimensions Maße	Lp. No. Lfd. Nr.	Nr art. Item No. Art.-Nr.	Kolor - Color - Farbe			Materiał Material Material	Oprawka Socket Fassung
			Abażur - Shade - Schirm	Podstawa - Base - Basis	Kabel - Cable - Kable		
	1	3751027	Beżowy - Beige - Beige	Satyna Satin Satin	Transparentny Transparent Transparent	Tkanina /Metal Fabric/Metal Stoff/Metall	1xE27 max. 60 W
	2	3752027	Szary - Grey - Grau				
	3	3754027	Zielony - Green - Grün				
	4	3755027	Bordowy - Burgundy - Burgund				
	5	6741027	Beżowy - Beige - Beige	Satyna Satin Satin	Transparentny Transparent Transparent	Tkanina /Metal Fabric/Metal Stoff/Metall	1xE27 max. 60 W
	6	6742027	Szary - Grey - Grau				
	7	6744027	Zielony - Green - Grün				
	8	6745027	Bordowy - Burgundy - Burgund				
	9	7751027	Beżowy - Beige - Beige	Satyna Satin Satin	Transparentny Transparent Transparent	Tkanina /Metal Fabric/Metal Stoff/Metall	1xE27 max. 40 W
	10	7752027	Szary - Grey - Grau				
	11	7754027	Zielony - Green - Grün				
	12	7755027	Bordowy - Burgundy - Burgund				

Made in Europe

Nr abażura/Shade No./Schirm-Nr.: Strona/Page/Seite: 316-317.

Z zastrzeżeniem zmian i możliwych błędów/Subject to changes and possible errors/Irrtümer und Änderungen vorbehalten.

LEILA



8) 6654028

Przykładowa konfiguracja/Example configuration/Beispielkonfiguration



3) 3563028

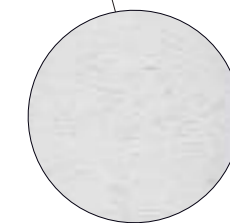

2) 3562028



1) 3561028

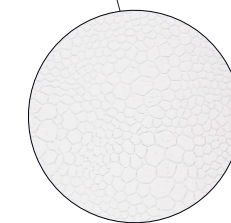

Przykładowa konfiguracja/Example configuration/Beispielkonfiguration

LEILA



11) 7653028



9) 7651028

Przykładowa konfiguracja/Example configuration/Beispielkonfiguration



Krokodyl - Crocodile - Krokodil



Drewno - Wood - Holz



Paisley - Paisley - Paisley



Kropki - Dots - Punkte

Dostępne konfiguracje/Available configurations/Verfügbare Konfigurationen

LEILA

Wymiary Dimensions Maße	Lp. No. Lfd. Nr.	Nr art. Item No. Art.-Nr.	Wzór/Kolor - Design/Color - Muster/Farbe			Materiał Material Material	Oprawka Socket Fassung
			Abażur - Shade - Schirm	Podstawa - Base - Basis	Kabel - Cable - Kable		
	1	3561028	Krokodyl - Crocodile - Krokodil	Chrom Chrome Chrom	Transparentny Transparent Transparent	Papier+PCV/Metal Paper+PCV/Metal Papier+PCV/Metall	1xE27 max. 60 W
	2	3562028	Drewno - Wood - Holz				
	3	3563028	Paisley - Paisley - Paisley				
	4	3564028	Kropki - Dots - Punkte				
	5	6651028	Krokodyl - Crocodile - Krokodil	Chrom Chrome Chrom	Transparentny Transparent Transparent	Papier+PCV/Metal Paper+PCV/Metal Papier+PCV/Metall	1xE27 max. 60 W
	6	6652028	Drewno - Wood - Holz				
	7	6653028	Paisley - Paisley - Paisley				
	8	6654028	Kropki - Dots - Punkte				
	9	7651028	Krokodyl - Crocodile - Krokodil	Chrom Chrome Chrom	Transparentny Transparent Transparent	Papier+PCV/Metal Paper+PCV/Metal Papier+PCV/Metall	1xE27 max. 40 W
	10	7652028	Drewno - Wood - Holz				
	11	7653028	Paisley - Paisley - Paisley				
	12	7654028	Kropki - Dots - Punkte				

Made in Europe

Nr abażura/Shade No./Schirm-Nr.: Strona/Page/Seite: 317.

Z zastrzeżeniem zmian i możliwych błędów/Subject to changes and possible errors/Irrtümer und Änderungen vorbehalten.

MAXIMA



1) 1761028



2) 1762028



3) 1763028

Przykładowa konfiguracja/Example configuration/Beispielkonfiguration

MAXIMA



5) 6592028

Przykładowa konfiguracja/Example configuration/Beispielkonfiguration

Dostępne konfiguracje/Available configurations/Verfügbare Konfigurationen

MAXIMA

Wymiary Dimensions Maße	Lp. No. Lfd. Nr.	Nr art. Item No. Art.-Nr.	Kolor - Color - Farbe			Materiał Material Material	Oprawka Socket Fassung
			Abażur - Shade - Schirm	Podstawa - Base - Basis	Kabel - Cable - Kable		
	1	1761028	Biały - White - Weiss	Chrom Chrome Chrom	Transparentny Transparent Transparent	Tworzywo sztuczne/Metal Synthetic/Metal Kunststoff/Metall	1xE27 max. 60 W
	2	1762028	Czarny - Black - Schwarz				
	3	1763028	Srebrny - Silver - Silber				
	4	6591028	Biały - White - Weiss				
	5	6592028	Czarny - Black - Schwarz				
	6	6593028	Srebrny - Silver - Silber				

Made in Europe

Nr abażura/Shade No./Schirm-Nr.: Strona/Page/Seite: 318.

Z zastrzeżeniem zmian i możliwych błędów/Subject to changes and possible errors/Irtümer und Änderungen vorbehalten.

TRIPOD



7) 6025004

Przykładowa konfiguracja/Example configuration/Beispielkonfiguration



2) 6024074

Przykładowa konfiguracja/Example configuration/Beispielkonfiguration



5) 6025076

TRIPOD



11) 6111076



13) 6111004

Przykładowa konfiguracja/Example configuration/Beispielkonfiguration

Dostępne konfiguracje/Available configurations/Verfügbare Konfigurationen



TRIPOD

Wymiary Dimensions Maße	Lp. No. Lfd. Nr.	Nr art. Item No. Art.-Nr.	Kolor - Color - Farbe			Materiał Material Material	Oprawa Socket Fassung
			Podstawa - Base - Fuss	Abażur - Shade - Schirm	Kabel - Cable - Kabel		
	1	6021074	Dąb olejowany Oiled oak Eiche geölt	Biały - White - Weiss	Transparentny Transparent Transparent	Drewno dębowe/Tkanina Oak wood/Fabric Eichenholz/Stoff	1xE27 max. 60 W
	2	6024074		Antracyt - Dark grey - Anthrazit			
	3	6025074		Czarny - Black - Schwarz			
	4	6021076	Orzech Walnut Walnuss	Biały - White - Weiss			
		5		6025076			
	6	6021004	Czarny Black Schwarz	Biały - White - Weiss			
		7		6025004			
	8	6111074	Dąb olejowany Oiled oak Eiche geölt	Biały - White - Weiss	Drewno dębowe/Tkanina Oak wood/Fabric Eichenholz/Stoff	1xE27 max. 40 W	
	9	6114074		Antracyt - Dark grey - Anthrazit			
	10	6115074		Czarny - Black - Schwarz			
	11	6111076	Orzech Walnut Walnuss	Biały - White - Weiss			
		12		6115076			Czarny - Black - Schwarz
	13	6111004	Czarny Black Schwarz	Biały - White - Weiss			
		14		6115004			Czarny - Black - Schwarz

Made in Europe

Nr abażura/Shade No./Schirm-Nr.: Strona/Page/Seite: 318.

Z zastrzeżeniem zmian i możliwych błędów/Subject to changes and possible errors/Irrtümer und Änderungen vorbehalten.

RUNE



1) 6221074

Przykładowa konfiguracja/Example configuration/Beispielkonfiguration



5) 6225076

Przykładowa konfiguracja/Example configuration/Beispielkonfiguration



4) 6221076

RUNE



8) 6315074



6) 6311074

Przykładowa konfiguracja/Example configuration/Beispielkonfiguration



Dostępne konfiguracje/Available configurations/Verfügbare Konfigurationen

RUNE

Wymiary Dimensions Maße	Lp. No. Lfd. Nr.	Nr art. Item No. Art.-Nr.	Kolor - Color - Farbe			Materiał Material Material	Oprawa Socket Fassung
			Podstawa - Base - Fuss	Abażur - Shade - Schirm	Kabel - Cable - Kabel		
	1	6221074	Dąb olejowany Oiled oak Eiche geölt	Biały - White - Weiss	Transparentny Transparent Transparent	Drewno dębowe/Tkanina Oak wood/Fabric Eichenholz/Stoff	1xE27 max. 60 W
	2	6224074		Antracyt - Dark grey - Anthrazit			
	3	6225074		Czarny - Black - Schwarz			
	4	6221076	Orzech Walnut Walnuss	Biały - White - Weiss			
	5	6225076		Czarny - Black - Schwarz			
	6	6311074	Dąb olejowany Oiled oak Eiche geölt	Biały - White - Weiss	Drewno dębowe/Tkanina Oak wood/Fabric Eichenholz/Stoff	1xE27 max. 40 W	
	7	6314074		Antracyt - Dark grey - Anthrazit			
	8	6315074		Czarny - Black - Schwarz			
	9	6311076	Orzech Walnut Walnuss	Biały - White - Weiss			
	10	6315076		Czarny - Black - Schwarz			

Made in Europe

Nr abażura/Shade No./Schirm-Nr.: Strona/Page/Seite: 318.

Z zastrzeżeniem zmian i możliwych błędów/Subject to changes and possible errors/Irrtümer und Änderungen vorbehalten.

WOODDREAM



3) 2566376



5) 2566360



Dostępne konfiguracje/Available configurations/Verfügbare Konfigurationen

WOODDREAM ROUND

Wymiary Dimensions Maße	Lp. No. Lfd. Nr.	Nr art. Item No. Art.-Nr.	Źródło światła Light source Lichtquelle	Kolor Color Farbe	Materiał Material Material
	1	2566374	Incl. 3xLED GU10 5 W 320 lm, 2700 K, RA 90	Dąb olejowany Oiled Oak Eiche geölt	Drewno dębowe Oak wood Eichenholz
	2	2066374	3xGU10 max. 6 W		
	3	2566376	Incl. 3xLED GU10 5 W 320 lm, 2700 K, RA 90	Orzech Walnut Nussbaum	Drewno bukowe Beech wood Buchenholz
	4	2066376	3xGU10 max. 6 W		
	5	2566360	Incl. 3xLED GU10 5 W 320 lm, 2700 K, RA 90	Brzoza Birch Birke	Drewno brzozowe Birch wood Birkenholz
	6	2066360	3xGU10 max. 6 W		

Made in Europe

Z zastrzeżeniem zmian i możliwych błędów/Subject to changes and possible errors/Irrtümer und Änderungen vorbehalten.

WOODDREAM



5) 2576360



3) 2576376

Dostępne konfiguracje/Available configurations/Verfügbare Konfigurationen



WOODDREAM CUBE

Wymiary Dimensions Maße	Lp. No. Lfd. Nr.	Nr art. Item No. Art.-Nr.	Źródło światła Light source Lichtquelle	Kolor Color Farbe	Materiał Material Material
	1	2576374	Incl. 3xLED GU10 5 W 320 lm, 2700 K, Ra>90	Dąb olejowany Oiled Oak Eiche geölt	Drewno dębowe Oak wood Eichenholz
	2	2076374	3xGU10 max. 6 W		
	3	2576376	Incl. 3xLED GU10 5 W 320 lm, 2700 K, Ra>90	Orzech Walnut Nussbaum	Drewno bukowe Beech wood Buchenholz
	4	2076376	3xGU10 max. 6 W		
	5	2576360	Incl. 3xLED GU10 5 W 320 lm, 2700 K, Ra>90	Brzoza Birch Birke	Drewno brzozowe Birch wood Birkenholz
	6	2076360	3xGU10 max. 6 W		

Made in Europe

Z zastrzeżeniem zmian i możliwych błędów/Subject to changes and possible errors/Irrtümer und Änderungen vorbehalten.

WOODDREAM



1) 2566174



5) 2566160



3) 2566176



Dostępne konfiguracje/Available configurations/Verfügbare Konfigurationen

WOODDREAM ROUND

Wymiary Dimensions Maße	Lp. No. Lfd. Nr.	Nr art. Item No. Art.-Nr.	Źródło światła Light source Lichtquelle	Kolor Color Farbe	Materiał Material Material
	1	2566174	Incl. 1xLED GU10 5 W 320 lm, 2700 K, Ra>90	Dąb olejowany Oiled Oak Eiche geölt	Drewno dębowe Oak wood Eichenholz
	2	2066174	1xGU10 max. 6 W		
	3	2566176	Incl. 1xLED GU10 5 W 320 lm, 2700 K, Ra>90	Orzech Walnut Nussbaum	Drewno bukowe Beech wood Buchenholz
	4	2066176	1xGU10 max. 6 W		
	5	2566160	Incl. 1xLED GU10 5 W 320 lm, 2700 K, Ra>90	Brzoza Birch Birke	Drewno brzożowe Birch wood Birkenholz
	6	2066160	1xGU10 max. 6 W		

Made in Europe

Z zastrzeżeniem zmian i możliwych błędów/Subject to changes and possible errors/Irrtümer und Änderungen vorbehalten.

WOODDREAM



5) 2576160



3) 2576176

Przykładowa konfiguracja/Example configuration/Beispielkonfiguration



Dostępne konfiguracje/Available configurations/Verfügbare Konfigurationen

WOODDREAM CUBE

Wymiary Dimensions Maße	Lp. No. Lfd. Nr.	Nr art. Item No. Art.-Nr.	Źródło światła Light source Lichtquelle	Kolor Color Farbe	Materiał Material Material
	1	2576174	Incl. 1xLED GU10 5 W 320 lm, 2700 K, Ra>90	Dąb olejowany Oiled Oak Eiche geölt	Drewno dębowe Oak wood Eichenholz
	2	2076174	1xGU10 max. 6 W		
	3	2576176	Incl. 1xLED GU10 5 W 320 lm, 2700 K, Ra>90	Orzech Walnut Nussbaum	Drewno bukowe Beech wood Buchenholz
	4	2076176	1xGU10 max. 6 W		
	5	2576160	Incl. 1xLED GU10 5 W 320 lm, 2700 K, Ra>90	Brzoza Birch Birke	Drewno brzozowe Birch wood Birkenholz
	6	2076160	1xGU10 max. 6 W		

Made in Europe

Z zastrzeżeniem zmian i możliwych błędów/Subject to changes and possible errors/Irrtümer und Änderungen vorbehalten.

CONCRETE DREAM



Przykładowa konfiguracja/Example configuration/Beispielkonfiguration



1) 2566136



3) 2566137

Dostępne konfiguracje/Available configurations/Verfügbare Konfigurationen

CONCRETE DREAM

Wymiary Dimensions Maße	Lp. No. Lfd. Nr.	Nr art. Item No. Art.-Nr.	Źródło światła Light source Lichtquelle	Kolor Color Farbe	Materiał Material Material
	1	2566136	Incl. 1xLED GU10 5 W 320 lm, 2700 K, Ra>90	Szary Grey Grau	Beton Concrete Beton
	2	2066136	1xGU10 max. 6 W		
	3	2566137	Incl. 1xLED GU10 5 W 320 lm, 2700 K, Ra>90	Biały White Weiss	
	4	2066137	1xGU10 max. 6 W		

Made in Europe

Z zastrzeżeniem zmian i możliwych błędów/Subject to changes and possible errors/Irrtümer und Änderungen vorbehalten.

CONCRETE DREAM



Przykładowa konfiguracja/Example configuration/Beispielkonfiguration



3) 2576137



1) 2576136

Dostępne konfiguracje/Available configurations/Verfügbare Konfigurationen

CONCRETE DREAM

Wymiary Dimensions Maße	Lp. No. Lfd. Nr.	Nr art. Item No. Art.-Nr.	Źródło światła Light source Lichtquelle	Kolor Color Farbe	Materiał Material Material
	1	2576136	Incl. 1xLED GU10 5 W 320 lm, 2700 K, Ra>90	Szary Grey Grau	Beton Concrete Beton
	2	2076136	1xGU10 max. 6 W		
	3	2576137	Incl. 1xLED GU10 5 W 320 lm, 2700 K, Ra>90	Biały White Weiss	
	4	2076137	1xGU10 max. 6 W		

Made in Europe

Z zastrzeżeniem zmian i możliwych błędów/Subject to changes and possible errors/Irrtümer und Änderungen vorbehalten.

VITAR WOOD



1) 2511174



3) 2511176



6) 2511360

Przykładowa konfiguracja/Example configuration/Beispielkonfiguration



Dostępne konfiguracje/Available configurations/Verfügbare Konfigurationen

VITAR WOOD

Wymiary Dimensions Maße	Lp. No. Lfd. Nr.	Nr art. Item No. Art.-Nr.	Źródło światła Light source Lichtquelle	Kolor Color Farbe	Materiał Material Material
	1	2511174	Incl. 1xLED GU10 5 W 320 lm, 2700 K, Ra>90	Dąb olejowany/Chrom Oiled Oak/Chrom Eiche geölt/Chrom	Drewno dębowe/Metal Oak wood/Metal Eichenholz/Metall
	2	2511374	Incl. 3xLED GU10 5 W 320 lm, 2700 K, Ra>90		
	3	2511176	Incl. 1xLED GU10 5 W 320 lm, 2700 K, Ra>90	Orzech/Chrom Walnut/Chrome Nussbaum/Chrom	Drewno bukowe/Metal Beech wood/Metal Buchenholz/Metall
	4	2511376	Incl. 3xLED GU10 5 W 320 lm, 2700 K, Ra>90		
	5	2511160	Incl. 1xLED GU10 5 W 320 lm, 2700 K, Ra>90	Brzoza/Chrom Birch/Chrome Birke/Chrom	Drewno brzozowe/Metal Birch wood/Metal Birkenholz/Metall
	6	2511360	Incl. 3xLED GU10 5 W 320 lm, 2700 K, Ra>90		

Made in Europe

Z zastrzeżeniem zmian i możliwych błędów/Subject to changes and possible errors/Irrtümer und Änderungen vorbehalten.

VITAR WOOD



3) 2515176

Przykładowa konfiguracja/Example configuration/Beispielkonfiguration



1) 2515174



1) 2515174



5) 2515160

Przykładowa konfiguracja/Example configuration/Beispielkonfiguration



VITAR WOOD

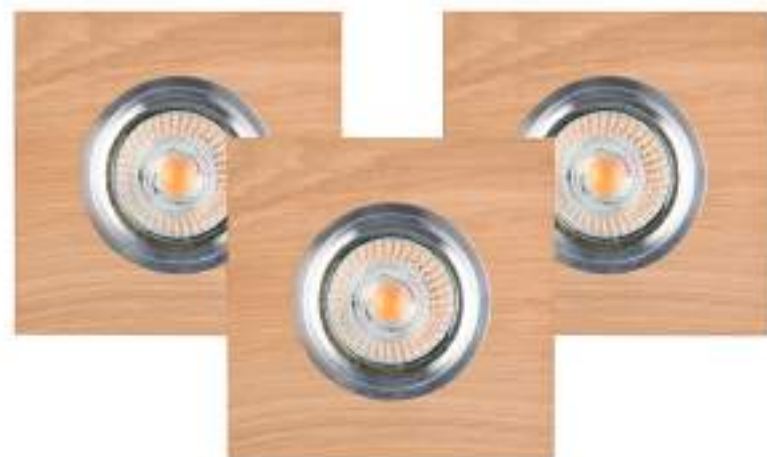

2) 2515374

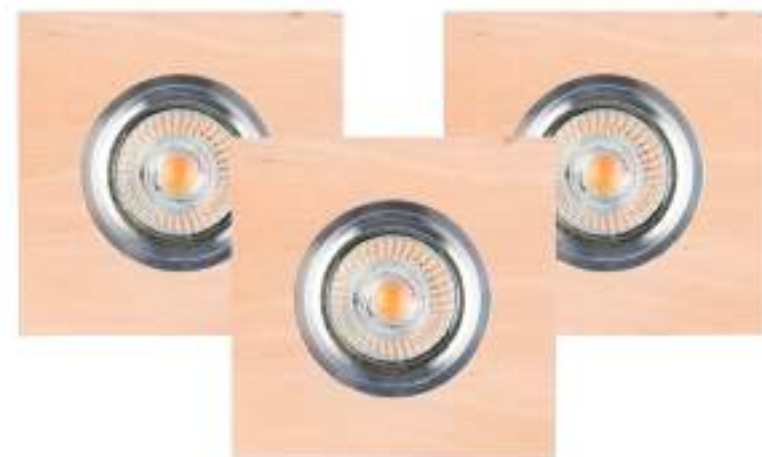

6) 2515360



4) 2515376

Przykładowa konfiguracja/Example configuration/Beispielkonfiguration



Dostępne konfiguracje/Available configurations/Verfügbare Konfigurationen

VITAR WOOD

Wymiary Dimensions Maße	Lp. No. Lfd. Nr.	Nr art. Item No. Art.-Nr.	Źródło światła Light source Lichtquelle	Kolor Color Farbe	Materiał Material Material
	1	2515174	Incl. 1xLED GU10 5 W 320 lm, 2700 K, Ra>90	Dąb olejowany/Chrom Oiled Oak/Chrom Eiche geölt/Chrom	Drewno dębowe/Metal Oak wood/Metal Eichenholz/Metall
	2	2515374	Incl. 3xLED GU10 5 W 320 lm, 2700 K, Ra>90		
	3	2515176	Incl. 1xLED GU10 5 W 320 lm, 2700 K, Ra>90	Orzech/Chrom Walnut/Chrome Nussbaum/Chrom	Drewno bukowe/Metal Beech wood/Metal Buchenholz/Metall
	4	2515376	Incl. 3xLED GU10 5 W 320 lm, 2700 K, Ra>90		
	5	2515160	Incl. 1xLED GU10 5 W 320 lm, 2700 K, Ra>90	Brzoza/Chrom Birch/Chrome Birke/Chrom	Drewno brzozowe/Metal Birch wood/Metal Birkenholz/Metall
	6	2515360	Incl. 3xLED GU10 5 W 320 lm, 2700 K, Ra>90		

Made in Europe

Z zastrzeżeniem zmian i możliwych błędów/Subject to changes and possible errors/Irrtümer und Änderungen vorbehalten.

VITAR WOOD



1) 2518174



5) 2518160



3) 2518176



2) 2518374

Dostępne konfiguracje/Available configurations/Verfügbare Konfigurationen



VITAR WOOD

Wymiary Dimensions Maße	Lp. No. Lfd. Nr.	Nr art. Item No. Art.-Nr.	Źródło światła Light source Lichtquelle	Kolor Color Farbe	Materiał Material Material
	1	2518174	Incl. 1xLED GU10 5 W 320 lm, 2700 K, Ra>90	Dąb olejowany/Chrom Oiled Oak/Chrom Eiche geölt/Chrom	Drewno dębowe/Metal Oak wood/Metal Eichenholz/Metall
	2	2518374	Incl. 3xLED GU10 5 W 320 lm, 2700 K, Ra>90		
	3	2518176	Incl. 1xLED GU10 5 W 320 lm, 2700 K, Ra>90	Orzech/Chrom Walnut/Chrome Nussbaum/Chrom	Drewno bukowe/Metal Beech wood/Metal Buchenholz/Metall
	4	2518376	Incl. 3xLED GU10 5 W 320 lm, 2700 K, Ra>90		
	5	2518160	Incl. 1xLED GU10 5 W 320 lm, 2700 K, Ra>90	Brzoza/Chrom Birch/Chrome Birke/Chrom	Drewno brzozowe/Metal Birch wood/Metal Birkenholz/Metall
	6	2518360	Incl. 3xLED GU10 5 W 320 lm, 2700 K, Ra>90		

Made in Europe

VITAR CONCRETE



5) 2511136



1) 2515136

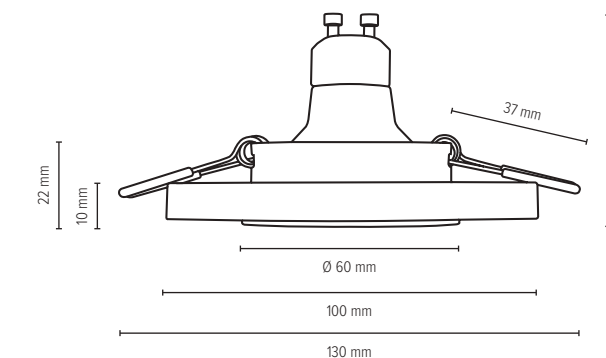

Dostępne konfiguracje/Available configurations/Verfügbare Konfigurationen

VITAR CONCRETE

Wymiary Dimensions Maße	Lp. No. Lfd. Nr.	Nr art. Item No. Art.-Nr.	Źródło światła Light source Lichtquelle	Kolor Color Farbe	Materiał Material Material
	1	2515136	Incl. 1xLED GU10 5 W 320 lm, 2700 K, Ra>90	Szary/Chrom Grey/Chrome	Beton/Metal Concrete/Metal Beton/Metall
	2	2515336	Incl. 3xLED GU10 5 W 320 lm, 2700 K, Ra>90	Grau/Chrom	
	3	2515137	Incl. 1xLED GU10 5 W 320 lm, 2700 K, Ra>90	Biały/Chrom White/Chrome	
	4	2515337	Incl. 3xLED GU10 5 W 320 lm, 2700 K, Ra>90	Weiss/Chrom	
	5	2511136	Incl. 1xLED GU10 5 W 320 lm, 2700 K, Ra>90	Szary/Chrom Grey/Chrome	
	6	2511336	Incl. 3xLED GU10 5 W 320 lm, 2700 K, Ra>90	Grau/Chrom	
	7	2511137	Incl. 1xLED GU10 5 W 320 lm, 2700 K, Ra>90	Biały/Chrom White/Chrome	
	8	2511337	Incl. 3xLED GU10 5 W 320 lm, 2700 K, Ra>90	Weiss/Chrom	

Made in Europe

Z zastrzeżeniem zmian i możliwych błędów/Subject to changes and possible errors/Irrtümer und Änderungen vorbehalten.

VITAR SANDSTONE



1) 2515139



3) 2511139

Przykładowa konfiguracja/Example configuration/Beispielkonfiguration



4) 2511339

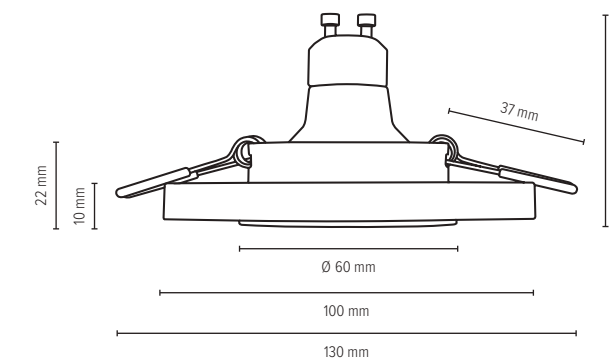

Dostępne konfiguracje/Available configurations/Verfügbare Konfigurationen

VITAR SANDSTONE

Wymiary Dimensions Maße	Lp. No. Lfd. Nr.	Nr art. Item No. Art.-Nr.	Źródło światła Light source Lichtquelle	Kolor Color Farbe	Materiał Material Material
	1	2515139	Incl. 1xLED GU10 5 W 320 lm, 2700 K, Ra>90	Piaskowiec/Chrom Sandstone/Chrome Sandstein/Chrom	Piaskowiec/Metal Sandstone/Metal Sandstein/Metall
	2	2515339	Incl. 3xLED GU10 5 W 320 lm, 2700 K, Ra>90		
	3	2511139	Incl. 1xLED GU10 5 W 320 lm, 2700 K, Ra>90		
	4	2511339	Incl. 3xLED GU10 5 W 320 lm, 2700 K, Ra>90		

Made in Europe

Z zastrzeżeniem zmian i możliwych błędów/Subject to changes and possible errors/Irrtümer und Änderungen vorbehalten.

CRISTALDREAM



1) 6126501



2) 6123501

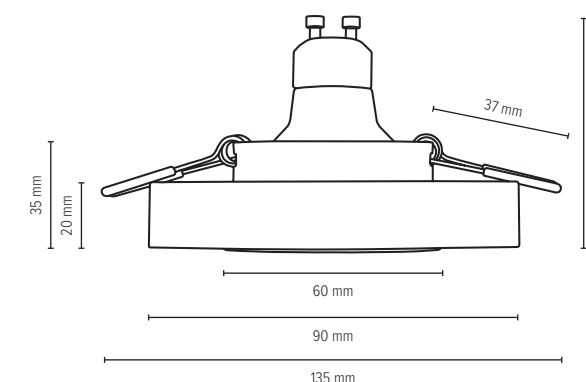

Dostępne konfiguracje/Available configurations/Verfügbare Konfigurationen

CRISTALDREAM

Wymiary Dimensions Maße	Lp. No. Lfd. Nr.	Nr art. Item No. Art.-Nr.	Źródło światła Light source Lichtquelle	Szkło Glass Glas	Materiał Material Material
	1	6126501	Incl. 1xLED GU10 5 W 320 lm, 2700 K, Ra>90	Transparentny Transparent Transparent	Szkło/Metal Glass/Metal Glas/Metall
	2	6123501	Incl. 1xLED GU10 5 W 320 lm, 2700 K, Ra>90		

Made in Europe

Z zastrzeżeniem zmian i możliwych błędów/Subject to changes and possible errors/Irrtümer und Änderungen vorbehalten.

CRISTALDREAM



1) 6115501



2) 6127501

Dostępne konfiguracje/Available configurations/Verfügbare Konfigurationen

CRISTALDREAM

Wymiary Dimensions Maße	Lp. No. Lfd. Nr.	Nr art. Item No. Art.-Nr.	Źródło światła Light source Lichtquelle	Z regulacją Adjustable Verstellbar	Szkoło Glass Glas	Materiał Material Material
	1	6115501	Incl. 1xLED GU10 5 W 320 lm, 2700 K, Ra>90	Tak - Yes - Ja	Transparentny Transparent Transparent	Szkło/Metal Glass/Metal Glas/Metall
	2	6127501	Incl. 1xLED GU10 5 W 320 lm, 2700 K, Ra>90	Nie - No - Nein		
	3	6127531	Incl. 3xLED GU10 5 W 320 lm, 2700 K, Ra>90			

Made in Europe

Z zastrzeżeniem zmian i możliwych błędów/Subject to changes and possible errors/Irtümer und Änderungen vorbehalten.

LESDREAM ROUND



1) 2601102



3) 2601128



4) 2601129



7) 2601111



4) 2601328



8) 2601311

Dostępne konfiguracje/Available configurations/Verfügbare Konfigurationen

LESDREAM ROUND

Wymiary Dimensions Maße	Lp. No. Lfd. Nr.	Nr art. Item No. Art.-Nr.	Źródło światła Light source Lichtquelle	Kolor/Wykończenie Color/Finish Farbe/Finish	Materiał Material Material
	1	2601102	Incl. 1xLED GU10 5 W 320 lm, 2700 K, Ra>90	Biały White Weiss	Metal Metal Metall
	2	2601302	Incl. 3xLED GU10 5 W 320 lm, 2700 K, Ra>90		
	3	2601128	Incl. 1xLED GU10 5 W 320 lm, 2700 K, Ra>90	Chrom Chrome Chrom	
	4	2601328	Incl. 3xLED GU10 5 W 320 lm, 2700 K, Ra>90		
	5	2601129	Incl. 1xLED GU10 5 W 320 lm, 2700 K, Ra>90	Satyna Satin Satin	
	6	2601329	Incl. 3xLED GU10 5 W 320 lm, 2700 K, Ra>90		
	7	2601111	Incl. 1xLED GU10 5 W 320 lm, 2700 K, Ra>90	Patyna Antique brass Altmessing	
	8	2601311	Incl. 3xLED GU10 5 W 320 lm, 2700 K, Ra>90		

Made in Europe

LESDREAM SQUARE



1) 2605102



3) 2605128



5) 2605129



7) 2605111



2) 2605302



6) 2605329

Dostępne konfiguracje/Available configurations/Verfügbare Konfigurationen

LESDREAM SQUARE

Wymiary Dimensions Maße	Lp. No. Lfd. Nr.	Nr art. Item No. Art.-Nr.	Źródło światła Light source Lichtquelle	Kolor/Wykończenie Color/Finish Farbe/Finish	Materiał Material Material
	1	2605102	Incl. 1xLED GU10 5 W 320 lm, 2700 K, Ra>90	Biały White Weiss	Metal Metal Metall
	2	2605302	Incl. 3xLED GU10 5 W 320 lm, 2700 K, Ra>90		
	3	2605128	Incl. 1xLED GU10 5 W 320 lm, 2700 K, Ra>90	Chrom Chrome Chrom	
	4	2605328	Incl. 3xLED GU10 5 W 320 lm, 2700 K, Ra>90		
	5	2605129	Incl. 1xLED GU10 5 W 320 lm, 2700 K, Ra>90	Satyna Satin Satin	
	6	2605329	Incl. 3xLED GU10 5 W 320 lm, 2700 K, Ra>90		
	7	2605111	Incl. 1xLED GU10 5 W 320 lm, 2700 K, Ra>90	Patyna Antique brass Altmessing	
	8	2605311	Incl. 3xLED GU10 5 W 320 lm, 2700 K, Ra>90		









Made in Europe

Przykładowa konfiguracja/Example configuration/Beispielkonfiguration

Z zastrzeżeniem zmian i możliwych błędów/Subject to changes and possible errors/Irrtümer und Änderungen vorbehalten.









L131-1



320 Lumen	 20.000 h	 40.000 X	2.700 Kelvin
 Ra > 90	 100% 0% < 0,5s	36° 500 cd	
 +40° -15°	ø 50 x 53 mm	 GU10	

LF24

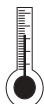

250 Lumen	 15.000 h	 30.000 X	2.200 Kelvin
 Ra > 90	 100% 0% < 0,5s		
 +40° -15°	ø 95 x 145 mm	 4 W; E27	

ABAŻUR - SHADE - SCHIRM

Lampa stołowa / Table lamp / Tischleuchte

Lp. No. Lfd. Nr.	Kolor Color Farbe	Nr Art. Item No. Art.-Nr.	Wymiary Dimensions Maße
1	Biały - White - Weiss	A0247	↔ 300 mm ↕ 180 mm
2	Kremowy - Ecru - Natur	A0245	
3	Czarny - Black - Schwarz	A0248	

MARINNA



Lampa sufitowa / Ceiling lamp / Deckenleuchte

Lp. No. Lfd. Nr.	Kolor Color Farbe	Nr Art. Item No. Art.-Nr.	Wymiary Dimensions Maße
1	Biały - White - Weiss	A0744	↔ 280 mm ↕ 130 mm
2	Brązowy - Brown - Braun	A0753	
3	Antracyt - Dark grey - Anthrazit	A0750	

JOSEFINA



Lampa sufitowa / Ceiling lamp / Deckenleuchte

Lp. No. Lfd. Nr.	Kolor Color Farbe	Nr Art. Item No. Art.-Nr.	Wymiary Dimensions Maße
1	Biały - White - Weiss	A0745	↔ 380 mm ↕ 130 mm
2	Brązowy - Brown - Braun	A0754	
3	Antracyt - Dark grey - Anthrazit	A0751	

JOSEFINA



Lampa sufitowa / Ceiling lamp / Deckenleuchte

Lp. No. Lfd. Nr.	Kolor Color Farbe	Nr Art. Item No. Art.-Nr.	Wymiary Dimensions Maße
1	Biały - White - Weiss	A0746	↔ 480 mm ↕ 130 mm
2	Brązowy - Brown - Braun	A0755	
3	Antracyt - Dark grey - Anthrazit	A0752	

JOSEFINA



Lampa wisząca / Pendant / Pendelleuchte

Lp. No. Lfd. Nr.	Kolor Color Farbe	Nr Art. Item No. Art.-Nr.	Wymiary Dimensions Maße
1	Biały - White - Weiss	A0601	↔ 500 mm ↕ 135 mm
2	Brązowy - Brown - Braun	A0602	
3	Antracyt - Dark grey - Anthrazit	A0603	

JOSEFINA



Lampa podłogowa i wisząca / Floor lamp and Pendant / Steh- und Pendelleuchte

Lp. No. Lfd. Nr.	Kolor Color Farbe	Nr Art. Item No. Art.-Nr.	Wymiary Dimensions Maße
1	Beżowy - Beige - Beige	A0573	↔ 500 mm ↕ 260 mm
2	Szary - Grey - Grau	A0574	
3	Bordowy - Burgundy - Burgund	A0577	
4	Zielony - Green - Grün	A0576	

SCARLETT



ABAŻUR - SHADE - SCHIRM

Lampa stołowa / Table lamp / Tischleuchte

Lp. No. Lfd. Nr.	Kolor Color Farbe	Nr Art. Item No. Art.-Nr.	Wymiary Dimensions Maße
1	Beżowy - Beige - Beige	A0578	↔ 250 mm ↕ 180 mm
2	Szary - Grey - Grau	A0579	
3	Bordowy - Burgundy - Burgund	A0582	
4	Zielony - Green - Grün	A0581	

SCARLETT



1 2 3 4

Lampa podłogowa i wisząca / Floor lamp and Pendant / Steh- und Pendelleuchte

Lp. No. Lfd. Nr.	Kolor Color Farbe	Nr Art. Item No. Art.-Nr.	Wymiary Dimensions Maße
1	Biały - White - Weiss	A0727	↔ 500 mm ↕ 160 mm
2	Czarny - Black - Schwarz	A0729	
3	Srebrny - Silver - Silber	A0731	

MAXIMA



1 2 3

Lampa podłogowa i wisząca / Floor lamp and Pendant / Steh- und Pendelleuchte

Lp. No. Lfd. Nr.	Kolor Color Farbe	Nr Art. Item No. Art.-Nr.	Wymiary Dimensions Maße
1	Krokodyl - Crocodile - Krokodil	A0436	↔ 500 mm ↕ 260 mm
2	Drewno - Wood - Holz	A0437	
3	Paisley - Paisley - Paisley	A0438	
4	Kropki - Dots - Punkte	A0439	

LEILA



1 2 3 4

Lampa podłogowa / Floor lamp / Stehleuchte

Lp. No. Lfd. Nr.	Kolor Color Farbe	Nr Art. Item No. Art.-Nr.	Wymiary Dimensions Maße
1	Biały - White - Weiss	A0855	↔ 500 mm ↕ 260 mm
2	Antracyt - Dark grey - Anthrazit	A0858	
3	Czarny - Black - Schwarz	A0859	

TRIPOD / RUNE



1 2 3

Lampa stołowa / Table lamp / Tischleuchte

Lp. No. Lfd. Nr.	Kolor Color Farbe	Nr Art. Item No. Art.-Nr.	Wymiary Dimensions Maße
1	Krokodyl - Crocodile - Krokodil	A0440	↔ 250 mm ↕ 180 mm
2	Drewno - Wood - Holz	A0441	
3	Paisley - Paisley - Paisley	A0442	
4	Kropki - Dots - Punkte	A0443	

LEILA



1 2 3 4

Lampa stołowa / Table lamp / Tischleuchte

Lp. No. Lfd. Nr.	Kolor Color Farbe	Nr Art. Item No. Art.-Nr.	Wymiary Dimensions Maße
1	Biały - White - Weiss	A0850	↔ 300 mm ↕ 215 mm
2	Antracyt - Dark grey - Anthrazit	A0853	
3	Czarny - Black - Schwarz	A0854	

TRIPOD / RUNE



1 2 3

KOLOR DREWNA - WOOD COLOR - HOLZFARBE



Dąb olejowany
Oiled Oak
Eiche geölt

Dąb bielony
Oak white
Eiche Weiss

Orzech
Walnut
Nussbaum

Brzoza
Birch
Birke

Sosna naturalna
Natural pine
Kiefer Natur

Sosna bejcowana
Stained pine
Kiefer Gebeizt

Drewno jest produktem naturalnym, dlatego też różnice w usłojeniu, wybarwieniu, niewielkie odchylenia od podanych wymiarów, sęki, jak również zmiana koloru drewna pod wpływem kontaktu ze światłem słonecznym nie stanowią wady produktu i nie mogą stanowić podstawy reklamacji.

Wood is a natural product, therefore variations in grain, color, slight deviations from the specified dimensions as well as knots and changes in the wood color due to sun exposure are not a defect of the product and therefore can not result in complaints.

Holz ist ein Naturprodukt, daher sind Unterschiede in der Maserung, Färbung, geringfügige Abweichungen von den angegebenen Maßen sowie Äste und Veränderungen in der Holzfarbe durch Sonneneinstrahlung kein Mangel des Produkts und können keine Grundlage für Beanstandungen sein.

SPIS TREŚCI - CONTENT - INHALTSÜBERSICHT

ALESSANDRO.....	93	KARLA.....	237	SUNNIVA	141
AMORY	233	LESDREAM ROUND	311	SVANTJE.....	161
ASTRID CLIPS	185	LESDREAM SQUARE.....	313	SVEA.....	103
AURA	101	LEILA	267	SVENDA.....	157
BALL	149	LINEA.....	97	SVENDA CLIPS	183
BALL CONCRETE.....	249	LUCAS.....	73	TAVOLI.....	21
BALL WOOD	41	MARINNA.....	189	TAVOLI GLASS.....	19
BALL WOOD	151	MAXIMA.....	271	THEO	193
BIRGIT.....	173	MEGAN	165	TRABO LONG.....	51
BLOCK	225	MEGAN CLIPS.....	187	TRABO SHORT	55
BOSCO	107	MEGAN WOOD.....	167	TRABO CONCRETE.....	63
CARSTEN WOOD.....	47	METTE	127	TRABO PINO.....	59
CONCRETE DREAM.....	291	METTE WOOD	129	TRABO SIMPLE.....	67
COOL.....	251	NORMAN	125	TRABO TABLE.....	71
CRISTALDREAM.....	307	NORMAN WOOD	121	TREEHOUSE	147
FINN	143	PARMA WOOD.....	137	TREEHOUSE CLIPS.....	181
FORTAN	215	PINO	81	TRIGONON	45
FRESH.....	241	PINO FLOOR.....	77	TRIPOD	275
FRIDA.....	145	PINO TABLE.....	79	TRONGO ROUND	85
GENTLE	245	RAMME.....	5	TRONGO TABLE	203
GITTAN	247	RIVOLI.....	119	TRONGO SQUARE	89
GREAT.....	243	ROCKY.....	255	VENLA.....	171
HEXAR	201	ROY	35	VILETTA WOOD	133
INGER.....	117	RUNE	281	VINCENT.....	197
JENTA.....	113	SANDY.....	211	VITAR CONCRETE.....	303
JONA	111	SCARLETT.....	263	VITAR SANDSTONE	305
KAGO	23	STRONG TABLE	217	VITAR WOOD	295
KAGO LED	13	STRONG DOUBLE	221	WOODDREAM	283
KARIN	175	STRONG PENDANT	229	WOODDREAM WALL	177

Nr art. Item No. Art.-Nr.	Strona Page Seite	Nr art. Item No. Art.-Nr.	Strona Page Seite	Nr art. Item No. Art.-Nr.	Strona Page Seite	Nr art. Item No. Art.-Nr.	Strona Page Seite	Nr art. Item No. Art.-Nr.	Strona Page Seite	Nr art. Item No. Art.-Nr.	Strona Page Seite	Nr art. Item No. Art.-Nr.	Strona Page Seite	Nr art. Item No. Art.-Nr.	Strona Page Seite
1271174	46	1860128	242	2222476	174	2236176F	182	2291137	254	2434474	172	2571274	180	3561028	270
1271976	46	1860136	242	2224132	160	2236176K	182	2291174	142	2434476	172	2571276	180	3562028	270
1408032	112	1860174	100	2224132WF	184	2236274	148	2291176	142	2511136	304	2576136	294	3563028	270
1408060	112	1860176	100	2224132WK	184	2236276	148	2291236	254	2511137	304	2576137	294	3564028	270
1408174	112	1860328R	242	2224160	160	2236374	148	2291237	254	2511139	306	2576160	290	3751027	266
1408976	112	1860336R	242	2224160WF	184	2236376	148	2291274	142	2511160	296	2576174	290	3752027	266
1450174	102	1860374R	100	2224160WK	184	2236474	148	2291276	142	2511174	296	2576176	290	3754027	266
1450176	102	1860376R	100	2224174	160	2236476	148	2291336	254	2511176	296	2576360	286	3755027	266
1450374	102	2066136	292	2224174WF	184	2239160	164	2291337	254	2511336	304	2576374	286	4022974	144
1450376	102	2066137	292	2224174WK	184	2239174	164	2291374	142	2511337	304	2576376	286	4022976	144
1650174	48	2066160	288	2224176	160	2239176	164	2291376	142	2511339	306	2581260	178	4032974	144
1651174	48	2066174	288	2224176F	184	2239260	164	2291436	254	2511360	296	2581274	178	4032976	144
1652174	48	2066176	288	2224176K	184	2239274	164	2291437	254	2511374	296	2581276	178	4753036	256
1720128	110	2066360	284	2224232	160	2239276	164	2291474	142	2511376	296	2601102	312	4753174	146
1720160	110	2066374	284	2224260	160	2239360	164	2291476	142	2515136	304	2601111	312	4753176	146
1720174	110	2066376	284	2224274	160	2239374	164	2321136	246	2515137	304	2601128	312	4753236	256
1720176	110	2071260	180	2224276	160	2239376	164	2321236	246	2515139	306	2601129	312	4753474	146
1720328	110	2071274	180	2224332	160	2239460	164	2321336	246	2515160	300	2601302	312	4753476	146
1720328R	110	2071276	180	2224360	160	2239474	164	2321436	246	2515174	300	2601311	312	4754036	256
1720360	110	2076136	294	2224374	160	2239476	164	2344160	170	2515176	300	2601328	312	4754174	146
1720374	110	2076137	294	2224376	160	2241136	244	2344174	170	2515336	304	2601329	312	4754176	146
1720376	110	2076160	290	2224432	160	2241236	244	2344176	170	2515337	304	2605102	314	4754236	256
1720428	110	2076174	290	2224460	160	2241336	244	2344260	170	2515339	306	2605111	314	4754474	146
1720460	110	2076176	290	2224474	160	2241436	244	2344274	170	2515360	300	2605128	314	4754476	146
1720474	110	2076360	286	2224476	160	2255136	226	2344276	170	2515374	300	2605129	314	4762802	258
1720476	110	2076374	286	2231160	176	2255137	226	2344360	170	2515376	300	2605302	314	4762812	258
1720560	110	2076376	286	2231174	176	2266360	198	2344374	170	2518160	302	2605311	314	4763802	258
1720574	110	2081260	178	2231176	176	2266374	198	2344376	170	2518174	302	2605328	314	4763812	258
1720576	110	2081274	178	2231260	176	2266376	198	2344460	170	2518176	302	2605329	314	4764802	258
1760128	96	2081276	178	2231274	176	2276360	200	2344474	170	2518360	302	2735102K	186	4764812	258
1760174	96	2222160	174	2231276	176	2276374	200	2344476	170	2518374	302	2735104K	186	4782802	258
1760176	96	2222174	174	2231360	176	2276376	200	2434160	172	2518376	302	2743102	166	4782812	258
1760328	96	2222176	174	2231374	176	2284174	118	2434174	172	2566136	292	2743102K	188	4783802	258
1760338	96	2222260	174	2231376	176	2284176	118	2434176	172	2566137	292	2743104	166	4783812	258
1760374	96	2222274	174	2231460	176	2284274	118	2434260	172	2566160	288	2743104K	188	4784802	258
1760374R	96	2222276	174	2231474	176	2284276	118	2434274	172	2566174	288	2743202	166	4784812	258
1760376	96	2222360	174	2231476	176	2284374	118	2434276	172	2566176	288	2743204	166	4792802	258
1760376R	96	2222374	174	2236174	148	2284376	118	2434360	172	2566360	284	2743302	166	4792812	258
1761028	274	2222376	174	2236174WF	182	2284474	118	2434374	172	2566374	284	2743304	166	4793802	258
1762028	274	2222460	174	2236174WK	182	2284476	118	2434376	172	2566376	284	2743402	166	4793812	258
1763028	274	2222474	174	2236176	148	2291136	254	2434460	172	2571260	180	2743404	166	4794802	258

Nr art. Item No. Art.-Nr.	Strona Page Seite	Nr art. Item No. Art.-Nr.	Strona Page Seite	Nr art. Item No. Art.-Nr.	Strona Page Seite	Nr art. Item No. Art.-Nr.	Strona Page Seite	Nr art. Item No. Art.-Nr.	Strona Page Seite	Nr art. Item No. Art.-Nr.	Strona Page Seite	Nr art. Item No. Art.-Nr.	Strona Page Seite	Nr art. Item No. Art.-Nr.	Strona Page Seite
4794812	258	5141376	44	6115501	310	7061174	88	7181974	206	7754027	266	8341174	132	9153174	18
5109182	150	5141376R	44	6123501	308	7061374L	88	7181976	206	7755027	266	8341176	132	9154174	30
5109184	150	5143174	44	6126501	308	7061374R	88	7191032	204	7819174	202	8341327	128	9154274	30
5109187	150	5143176	44	6127501	310	7061936	230	7191174	204	7819176	202	8341328	128	9154374	30
5109282	150	5143374	44	6127531	310	7069176	88	7191432	204	8141174	136	8341374	132	9154474	30
5109284	150	5143374R	44	6151074	16	7069376L	88	7191976	204	8141176	136	8341376	132	9154474L	30
5109287	150	5143376	44	6153074	16	7069376R	88	7199174	204	8141374	136	8341527	128	9156174	18
5109382	150	5143376R	44	6155074	16	7071032	210	7199176	204	8141376	136	8341528	128	9157174	18
5109384	150	5222174	40	6170936	218	7071174	210	7284174	118	8141574	136	8341574	132	9158174	30
5109387	150	5222274	40	6170937	218	7071432	210	7284176	118	8141576	136	8341576	132	9158274	30
5109482	150	5222374	40	6191936	220	7071976	210	7370936	222	8142174	136	8512174	116	9158374	30
5109484	150	5222474	40	6191937	220	7079174	210	7370937	222	8142374	136	8512176	116	9158474	30
5109487	150	5222474L	40	6221074	282	7079176	210	7381936	224	8152574	136	8512274	116	9158474L	30
5131136	250	5224174	40	6221076	282	7081174	206	7381937	224	8172136	248	8512276	116	9159174	34
5131174	154	5224274	40	6224074	282	7081432	206	7411936	246	8172236	248	8512374	116	9160136	238
5131176	154	5224374	40	6225074	282	7081976	206	7460160	196	8172336	248	8512376	116	9160336	238
5131236	250	5224474	40	6225076	282	7089136	232	7460174	196	8172436	248	8512474	116	9160336R	238
5131274	154	5224474L	40	6311074	282	7089336	232	7460176	196	8175128	126	8512476	116	9175960	124
5131276	154	5227174	40	6311076	282	7089436	232	7461160	196	8175160	124	8582128	120	9175974	124
5131336	250	5227274	40	6314074	282	7090039	212	7461174	196	8175174	124	8582228	120	9774136	236
5131374	154	5227374	40	6315074	282	7091039	212	7461176	196	8175228	126	8582328	120	9774336R	236
5131376	154	5227474	40	6315076	282	7154174	34	7462160	194	8175260	124	8582428	120	9776136	236
5131436	250	5227474L	40	6591028	274	7158174	34	7462174	194	8175274	124	8871974	22	9776336R	236
5131474	154	6021004	278	6592028	274	7161150	84	7462176	194	8175328	126	8872974	22	9779136	236
5131474L	154	6021074	278	6593028	274	7161174	92	7511936	244	8175360	124	8873974	22	9779336R	236
5131476	154	6021076	278	6651028	270	7161350	84	7522174	116	8175374	124	8881974	22	13560160	104
5131476L	154	6024074	278	6652028	270	7161350R	84	7522176	116	8175428	126	8882974	22	13560174	104
5133174	154	6025004	278	6653028	270	7161374L	92	7611042	192	8175460	124	8883974	22	13560176	104
5133176	154	6025074	278	6654028	270	7161474	92	7611074	192	8175474	124	8971136	228	51514274	34
5133274	154	6025076	278	6741027	266	7169176	92	7611076	192	8254136	216	8971137	228	51518274	34
5133276	154	6070936	218	6742027	266	7169336L	230	7612074	192	8254236	216	8972136	228	51524274	34
5133374	154	6070937	218	6744027	266	7169336R	230	7612076	192	8254336	216	8972137	228	51524374	34
5133376	154	6091936	220	6745027	266	7169376L	92	7615042	192	8254436	216	8973236	226	51528274	34
5133474	154	6091937	220	6834150	58	7169476	92	7615074	192	8320174	140	8973237	226	51528374	34
5133474L	154	6111004	278	6834151	58	7171032	208	7615076	192	8320176	140	9141174	8	57650127	260
5133476	154	6111074	278	6994150	70	7171174	208	7651028	270	8320374	140	9142274	8	57850127	260
5133476L	154	6111076	278	6994151	70	7171432	208	7652028	270	8320376	140	9143174	10	57950127	260
5141174	44	6114074	278	6996404	70	7171976	208	7653028	270	8320574	140	9144174	10	61500474	26
5141176	44	6115004	278	6998404	70	7179174	208	7654028	270	8320576	140	9145274	8	61501074	16
5141374	44	6115074	278	7011174	202	7179176	208	7751027	266	8341127	128	9150174	34	61503074	16
5141374R	44	6115076	278	7019176	202	7181032	206	7752027	266	8341128	128	9152174	16	61505074	16

Nr art. Item No. Art.-Nr.	Strona Page Seite	Nr art. Item No. Art.-Nr.	Strona Page Seite	Nr art. Item No. Art.-Nr.	Strona Page Seite	Nr art. Item No. Art.-Nr.	Strona Page Seite
61540174	26	76910150	72	A0601	318	G0651	256
61540474	26	76910151	72	A0602	318	G0652	146
61580174	26	76911150	72	A0603	318	G0652	256
61580474	26	76911151	72	A0722	116	G0768	176
61590474	26	77626904	80	A0722	246	G0770	110
61620474	36	77627904	80	A0727	320	G0770	238
61640474	36	87626904	78	A0729	320	G0833	102
61670474	36	87627904	78	A0731	320	G0867	96
68204304	58	91401174	8	A0744	317	G0901	104
68214304	58	91402274	8	A0745	317	G0903	144
68304304	58	91405274	8	A0746	318	G0905	144
68314304	58	91502174	16	A0750	317	G0960	160
68315350	62	91503174	18	A0751	317	G0960	184
68315351	62	91506174	18	A0752	318	G0997	140
68499304	66	91507174	18	A0753	317	G1518	164
68599304	66	A0245	317	A0754	317	G1545	100
69204304	54	A0247	317	A0755	318	G1545	242
69204504	54	A0248	317	A0850	320	P1027	54
69214304	54	A0321	206	A0853	320	P1027	58
69214504	54	A0321	220	A0854	320		
69304504	54	A0322	204	A0855	320		
69314504	54	A0322	212	A0858	320		
69315550	62	A0322	220	A0859	320		
69315551	62	A0436	319	A0994	118		
69369150	62	A0437	319	A0994	120		
69379151	62	A0438	319	A0994	244		
69399150	66	A0439	319	A0996	148		
69399151	66	A0440	319	A0996	182		
69460104	76	A0441	319	A1032	194		
69480104	76	A0442	319	A1032	224		
69499504	66	A0443	319	A1041	128		
69599504	66	A0510	78	A1041	132		
69660104	76	A0514	80	G0122	174		
69680104	76	A0573	318	G0492	22		
69860404	70	A0574	318	G0493	22		
69860604	70	A0576	318	G0590	136		
69880404	70	A0577	318	G0598	124		
69880604	70	A0578	319	G0598	126		
71689104	84	A0579	319	G0598	248		
71689304	84	A0581	319	G0635	112		
71689304R	84	A0582	319	G0651	146		

EAN INDEX

Nr art. Item No. Art.-Nr.	EAN	Nr art. Item No. Art.-Nr.	EAN	Nr art. Item No. Art.-Nr.	EAN	Nr art. Item No. Art.-Nr.	EAN
1271174	5901602351031	1760374	5901602370292	2081276	5901602358771	2224476	5907500150226
1271976	5907500156464	1760374R	5901602370315	2222160	5901602335840	2231160	5901602346150
13560160	5907500156846	1760376	5901602370308	2222174	5907500157652	2231174	5901602353530
13560174	5907500156822	1760376R	5901602371404	2222176	5907500157669	2231176	5907500157737
13560176	5907500156839	1761028	5901602361566	2222260	5901602335857	2231260	5901602346167
1408032	5907500156792	1762028	5901602361573	2222274	5907500157676	2231274	5901602353547
1408060	5907500156815	1763028	5903148485560	2222276	5907500157683	2231276	5907500157744
1408174	5901602351369	1860128	5905840201622	2222360	5901602335864	2231360	5901602346174
1408976	5907500156808	1860136	5907500151704	2222374	5907500157690	2231374	5901602353554
1450174	5901602360743	1860174	5907500157065	2222376	5907500157706	2231376	5907500157751
1450176	5907500157119	1860176	5907500157089	2222460	5901602335871	2231460	5901602346181
1450374	5901602360750	1860328R	5905840201639	2222474	5907500157713	2231474	5901602353561
1450376	5907500157126	1860336R	5907500151711	2222476	5907500157720	2231476	5907500157768
1650174	5905840203671	1860374R	5907500157096	2224132	5901602343104	2236174	5901602369111
1651174	5905840203695	1860376R	5907500157102	2224132WF	5901602361108	2236174WF	5901602361160
1652174	5905840203688	2066136	5901602361504	2224132WK	5901602361047	2236174WK	5901602361139
1720128	5905840200557	2066137	5905840205323	2224160	5901602345146	2236176	5907500156617
1720160	5907500156914	2066160	5901602358870	2224160WF	5900805049479	2236176F	5901602361184
1720174	5907500156853	2066174	5901602358856	2224160WK	5901602361085	2236176K	5901602361153
1720176	5907500156907	2066176	5901602358863	2224174	5901602342091	2236274	5901602369128
1720328	5905840200564	2066360	5905840200861	2224174WF	5901602315392	2236276	5907500156624
1720328R	5905840200571	2066374	5905840200847	2224174WK	5901602361030	2236374	5901602369135
1720360	5907500156945	2066376	5905840200854	2224176	5907500150196	2236376	5907500156631
1720374	5907500156921	2071260	5901602358818	2224176F	5901602361115	2236474	5901602369142
1720376	5907500156938	2071274	5901602358795	2224176K	5901602361092	2236476	5907500156648
1720428	5905840200588	2071276	5901602358801	2224232	5901602343111	2239160	5901602368497
1720460	5907500157003	2076136	5901602361511	2224260	5901602345153	2239174	5901602368411
1720474	5907500156983	2076137	5905840205330	2224274	5901602342084	2239176	5907500156655
1720476	5907500156990	2076160	5901602358849	2224276	5907500150202	2239260	5901602368510
1720560	5907500156976	2076174	5901602358825	2224332	5901602343128	2239274	5901602368428
1720574	5907500156952	2076176	5901602358832	2224360	5901602345160	2239276	5907500156662
1720576	5907500156969	2076360	5905840200830	2224374	5901602342077	2239360	5901602368534
1760128	5901602339077	2076374	5905840200816	2224376	5907500150219	2239374	5901602368442
1760176	5901602370285	2076376	5905840200823	2224432	5901602343135	2239376	5907500156679
1760328	5901602339084	2081260	5901602358788	2224460	5901602345177	2239460	5901602369845
1760338	5901602339091	2081274	5901602358757	2224474	5901602342060	2239474	5901602368459

Nr art. Item No. Art.-Nr.	EAN	Nr art. Item No. Art.-Nr.	EAN	Nr art. Item No. Art.-Nr.	EAN	Nr art. Item No. Art.-Nr.	EAN	Nr art. Item No. Art.-Nr.	EAN	Nr art. Item No. Art.-Nr.	EAN	Nr art. Item No. Art.-Nr.	EAN		
2239476	5907500156686	2344160	5901602358252	2515176	5901602337585	2601328	5905840200717	4754174	5901602364031	5131336	5901602314975	5224174	5900805044696	6153074	5901602368572
2241136	5901602369159	2344174	5901602358214	2515336	5901602363256	2601329	5905840200731	4754176	5901602304907	5131374	5901602315361	5224274	5900805044856	61540174	5901602366523
2241236	5901602369166	2344176	5901602361856	2515337	5901602363270	2605102	5905840200601	4754236	5907795176741	5131376	5905840204883	5224374	5900805044573	61540474	5901602366530
2241336	5901602369173	2344260	5901602358269	2515339	5905840200342	2605111	5905840200663	4754474	5907500157379	5131436	5901602314982	5224474	5905840200441	6155074	5901602368596
2241436	5901602369180	2344274	5901602358221	2515360	5901602363218	2605128	5905840200625	4754476	5907500157386	5131474	5901602314937	5224474L	5905840200472	61580174	5905840200366
2255136	5901602368602	2344276	5901602361863	2515374	5901602363195	2605129	5905840200649	4762802	5901602370087	5131474L	5905840200502	5227174	5900805044726	61580474	5905840200595
2255137	5907795177175	2344360	5901602358276	2515376	5901602363232	2605302	5905840200618	4762812	5901602395035	5131476	5905840204890	5227274	5900805044559	61590474	5901602367711
2266360	5907500159823	2344374	5901602358238	2518160	5901602345238	2605311	5905840200670	4763802	5901602370117	5131476L	5905840204906	5227374	5905840200434	61620474	5900805044412
2266374	5907500159168	2344376	5901602361870	2518174	5901602343999	2605328	5905840200632	4763812	5901602395042	5133174	5901602314364	5227474	5905840200465	61640474	5900805044405
2266376	5907500159175	2344460	5901602358283	2518176	5901602345221	2605329	5905840200656	4764802	5901602370148	5133176	5901602315071	5227474L	5905840200496	61670474	5900805044436
2276360	5907500158833	2344474	5901602358245	2518360	5901602363096	2735102K	5903148479514	4764812	5901602395400	5133274	5901602314371	57650127	5905840209369	6170936	5907500151797
2276374	5907500158819	2344476	5901602361887	2518374	5901602363157	2735104K	5903148479521	4782802	5901602370100	5133276	5901602315194	57850127	5905840209383	6170937	5907500151803
2276376	5907500158826	2434160	5907500157546	2518376	5901602363171	2743102	5901602348802	4782812	5901602395448	5133374	5901602314388	57950127	5905840209376	6191936	5907500151810
2284174	5901602369234	2434174	5907500157522	2566136	5901602397565	2743102K	5903148479446	4783802	5901602370131	5133376	5901602315200	6021004	5901602336205	6191937	5907500151827
2284176	5903148400129	2434176	5907500157539	2566137	5907795177014	2743104	5901602349007	4783812	5901602395455	5133474	5901602314395	6021074	5901602376928	6221074	5901602361665
2284274	5901602369241	2434260	5907500157577	2566160	5901602397510	2743104K	5903148479453	4784802	5901602370162	5133474L	5905840200519	6021076	5901602361610	6221076	5901602361702
2284276	5907795172200	2434274	5907500157553	2566174	5901602397541	2743202	5901602348932	4784812	5901602395462	5133476	5901602315217	6024074	5901602376898	6224074	5901602361689
2284374	5901602369258	2434276	5907500157560	2566176	5901602396759	2743204	5901602348970	4792802	5901602372265	5133476L	5905840204913	6025004	5901602336243	6225074	5901602361696
2284376	5907795172217	2434360	5907500157614	2566360	5901602397527	2743302	5901602348949	4792812	5901602395004	5141174	5901602361245	6025074	5901602376881	6225076	5901602361719
2284474	5901602369265	2434374	5907500157591	2566374	5901602397558	2743304	5901602348963	4793802	5901602372272	5141176	5901602361269	6025076	5901602361634	6311074	5901602361726
2284476	5907795172224	2434376	5907500157607	2566376	5901602396902	2743402	5901602349014	4793812	5901602395011	5141374	5901602361283	6070936	5907500151759	6311076	5901602361757
2291136	5901602369517	2434460	5907500157492	2571260	5901602390832	2743404	5901602348956	4794802	5901602372289	5141374R	5901602361320	6070937	5907500151766	6314074	5901602361733
2291137	5907795177359	2434474	5907500157621	2571274	5901602374610	3561028	5905840202230	4794812	5901602395028	5141376	5901602361306	6091936	5907500151773	6315074	5901602361740
2291174	5901602369555	2434476	5907500157485	2571276	5901602391471	3562028	5905840202247	5109182	5901602314289	5141376R	5901602361368	6091937	5907500151780	6315076	5901602361764
2291176	5903148400112	2511136	5903148479781	2576136	5901602397572	3563028	5905840202254	5109184	5901602314326	5143174	5901602361252	6111004	5901602336458	6591028	5903148485584
2291236	5901602369524	2511137	5903148479798	2576137	5907795177021	3564028	5905840202261	5109187	5901602315378	5143176	5901602361276	6111074	5901602376874	6592028	5903148485591
2291237	5907795177090	2511139	5901602345252	2576160	5901602397503	3751027	5905840207631	5109282	5901602314296	5143374	5901602361290	6111076	5901602361641	6593028	5903148485607
2291274	5901602369562	2511160	5901602337554	2576174	5901602397534	3752027	5905840207648	5109284	5901602314333	5143374R	5901602361344	6114074	5901602376843	6651028	5905840202278
2291276	5907795172163	2511174	5903148481265	2576176	5901602396780	3754027	5905840207662	5109287	5901602314258	5143376	5901602361313	6115004	5901602336496	6652028	5905840202285
2291336	5901602369531	2511176	5901602337561	2576360	5901602399965	3755027	5905840207679	5109382	5901602314302	5143376R	5901602361375	6115074	5901602376836	6653028	5905840202292
2291337	5907795177106	2511336	5901602363119	2576374	5901602399972	4022974	5901602335697	5109384	5901602314340	51514274	5905840201738	6115076	5901602361658	6654028	5905840202308
2291374	5901602369579	2511337	5901602363133	2576376	5901602399958	4022976	5901602304648	5109387	5901602314265	51518274	5905840201745	6115501	5905840200786	6741027	5905840207686
2291376	5907795172170	2511339	5905840200359	2581260	5901602397497	4032974	5901602335710	5109482	5901602314319	51524274	5905840201752	6123501	5905840200779	6742027	5905840207693
2291436	5901602369548	2511360	5901602362143	2581274	5901602397480	4032976	5901602304662	5109484	5901602314357	51524374	5905840201776	6126501	5905840200762	6744027	5905840207716
2291437	5907795177113	2511374	5901602363010	2581276	5901602392935	4753036	5901602369678	5109487	5901602314272	51528274	5905840201769	6127501	5905840200793	6745027	5905840207723
2291474	5901602369586	2511376	5901602363072	2601102	5905840200687	4753174	5901602364000	5131136	5901602314951	51528374	5905840201783	6127531	5905840200809	68204304	5905840206870
2291476	5907795172187	2515136	5901602313268	2601111	5905840200748	4753176	5901602304891	5131174	5901602315224	5222174	5900805044719	61500474	5900805045891	68214304	5905840206887
2321136	5901602373101	2515137	5901602382400	2601128	5905840200700	4753236	5907795176734	5131176	5905840204869	5222274	5900805044894	61501074	5905840202476	68304304	5905840206856
2321236	5901602373118	2515139	5901602345245	2601129	5905840200724	4753474	5907500157256	5131236	5901602314968	5222374	5900805044580	61503074	5905840202483	68314304	5905840206863
2321336	5901602373125	2515160	5901602337578	2601302	5905840200694	4753476	5907500157362	5131274	5901602314791	5222474	5905840200458	61505074	5905840202490	68315350	5905840208799
2321436	5901602373132	2515174	5903148481258	2601311	5905840200755	4754036	5901602369685	5131276	5905840204876	5222474L	5905840200489	6151074	5901602368275	68315351	5905840208928

Nr art. Item No. Art.-Nr.	EAN	Nr art. Item No. Art.-Nr.	EAN	Nr art. Item No. Art.-Nr.	EAN	Nr art. Item No. Art.-Nr.	EAN	Nr art. Item No. Art.-Nr.	EAN	Nr art. Item No. Art.-Nr.	EAN	Nr art. Item No. Art.-Nr.	EAN		
6834150	5905840208935	7071432	5901602338599	7199174	5901602358337	7819174	5901602358429	8341327	5901602362020	9145274	5905840202513	A0440	5905840202070	G0492	5905840202933
6834151	5905840208942	7071976	5907500157799	7199176	5901602358344	7819176	5901602358436	8341328	5901602362013	9150174	5905840200380	A0441	5905840202087	G0493	5905840202940
68499304	5905840209260	7079174	5907500157775	7284174	5907500157461	8141174	5907795175980	8341374	5901602362075	91502174	5905840202506	A0442	5905840202094	G0590	5901602311714
68599304	5905840209277	7079176	5907500159267	7284176	5907500157478	8141176	5901602361948	8341376	5901602362082	91503174	5905840202445	A0443	5905840202100	G0598	5901602306338
69204304	5905840205774	7081174	5901602346372	7370936	5907795176871	8141374	5907795175997	8341527	5901602362044	91506174	5905840202452	A0510	5901289713320	G0635	5901602315064
69204504	5905840205781	7081432	5901602346280	7370937	5907500151650	8141376	5901602361962	8341528	5901602362037	91507174	5905840202469	A0514	5901289713436	G0651	5901602316023
69214304	5905840206832	7081976	5901602335420	7381936	5907795176895	8141574	5907795176000	8341574	5901602362099	9152174	5901602366516	A0573	5905840207969	G0652	5901602316030
69214504	5905840206849	7089136	5907795177731	7381937	5907500151667	8141576	5901602361986	8341576	5901602362105	9153174	5901602366370	A0574	5905840207976	G0768	5901602329238
69304504	5905840205132	7089336	5907795177755	7460160	5907500158642	8142174	5901602361917	8512174	5901602371336	9154174	5901602366080	A0576	5905840207990	G0770	5901602329290
69314504	5905840206825	7089436	5907795177786	7460174	5907500158727	8142374	5901602361955	8512176	5907795172279	9154274	5901602366158	A0577	5905840208003	G0833	5901602335635
69315550	5905840208782	7090039	5901602358443	7460176	5907500158734	8152574	5901602361979	8512274	5901602371343	9154374	5901602366172	A0578	5905840208010	G0867	5901602347669
69315551	5905840208775	7091039	5901602358467	7461160	5907500158697	8172136	5907795177274	8512276	5907795172286	9154474	5901602366196	A0579	5905840208027	G0901	5901602348031
69369150	5905840209246	7154174	5901602366219	7461174	5907500158635	8172236	5907795177281	8512374	5901602371350	9154474L	5905840200946	A0581	5905840208041	G0903	5901602345719
69379151	5905840209253	7158174	5905840200373	7461176	5907500158680	8172336	5907795177298	8512376	5903148400013	9156174	5901602366400	A0582	5905840208058	G0905	5901602345702
69399150	5905840209307	7161150	5905840208850	7462160	5907500156600	8172436	5907795177304	8512474	5901602371367	9157174	5901602366509	A0601	5905840209390	G0960	5901602349328
69399151	5905840209314	7161174	5901602368725	7462174	5907500156587	8175128	5905840210358	8512476	5903148400020	9158174	5905840200427	A0602	5905840209406	G0997	5901602396278
69460104	5905840209758	7161350	5905840208911	7462176	5907500156594	8175160	5905840210280	8582128	5901602372029	9158274	5905840200410	A0603	5905840209413	G1518	5901602386866
69480104	5905840209765	7161350R	5905840208867	7522174	5907500157393	8175174	5905840210273	8582228	5901602372036	9158374	5905840200403	A0722	5901602383667	G1545	5901602306710
69499504	5905840209284	7161374L	5901602358733	7522176	5907500157409	8175228	5905840210365	8582328	5901602372043	9158474	5905840200397	A0727	5901602383711	L131-1	5905840210662
69599504	5905840209291	7161474	5907795170800	7611042	5907500156563	8175260	5905840210303	8582428	5901602372050	9158474L	5905840200953	A0729	5901602383735	LF24	5905840210679
69660104	5905840209055	71689104	5905840209420	7611074	5907500156518	8175274	5905840210297	87626904	5905840209222	9159174	5901602366356	A0731	5901602383759		
69680104	5905840209062	71689304	5905840209444	7611076	5907500156532	8175328	5905840210372	87627904	5905840209239	9160136	5907500151728	A0744	5901602383889		
69860404	5905840208959	71689304R	5905840209437	7612074	5903148479705	8175360	5905840210327	8871974	5900805040025	9160336	5907500151742	A0745	5901602383896		
69860604	5905840208973	7169176	5901602358726	7612076	5907500156549	8175374	5905840210310	8872974	5900805040032	9160336R	5907500151735	A0746	5901602383902		
69880404	5905840208966	7169336L	5901602358047	7615042	5907500156570	8175428	5905840210389	8873974	5900805040049	9175960	5905840210402	A0750	5901602383940		
69880604	5905840208980	7169336R	5903148439693	7615074	5907500156525	8175460	5905840210341	8881974	5900805044375	9175974	5905840210396	A0751	5901602383957		
6994150	5905840209017	7169376L	5901602358740	7615076	5907500156556	8175474	5905840210334	8882974	5900805044382	9774136	5901602373408	A0752	5901602383964		
6994151	5905840209024	7169476	5901602358764	7651028	5905840202315	8254136	5905840209710	8883974	5900805044399	9774336R	5907500151698	A0753	5901602383971		
6996404	5905840208997	7171032	5907500157812	7652028	5905840202322	8254236	5905840209727	8971136	5901602372296	9776136	5901602373415	A0754	5901602383988		
6998404	5905840209000	7171174	5901602341322	7653028	5905840202339	8254336	5905840209734	8971137	5907795177182	9776336R	5907500151681	A0755	5901602383995		
7011174	5901602303658	7171432	5901602338773	7654028	5905840202346	8254436	5905840209741	8972136	5901602372302	9779136	5901602373392	A0850	5901602345344		
7019176	5901602303689	7171976	5907500157829	76910150	5905840208812	8320174	5903148439648	8972137	5907795177038	9779336R	5907500151674	A0853	5901602345429		
7061174	5901602368695	7179174	5907500157805	76910151	5905840208805	8320176	5901602361450	8973236	5901602361481	A0245	5905840201578	A0854	5901602345436		
7061374L	5901602358498	7179176	5907500159205	76911150	5905840208829	8320374	5903148439655	8973237	5901602361498	A0247	5905840201592	A0855	5901602345450		
7061374R	5901602358511	7181032	5901602358207	76911151	5905840209093	8320376	5901602361467	91401174	5905840203336	A0248	5905840201608	A0858	5901602345474		
7061936	5901602380512	7181974	5901602358177	7751027	5905840207730	8320574	5903148439662	91402274	5905840203329	A0321	5903148487731	A0859	5901602345481		
7069176	5901602358481	7181976	5901602358191	7752027	5905840207747	8320576	5901602361474	91405274	5905840203343	A0322	5903148487748	A0994	5901602373972		
7069376L	5901602358504	7191032	5901602358351	7754027	5905840207761	8341127	5901602362006	9141174	5901602366042	A0436	5905840202032	A0996	5901602383605		
7069376R	5901602358528	7191174	5901602346600	7755027	5905840207778	8341128	5901602361993	9142274	5901602366035	A0437	5905840202049	A1032	5902166901779		
7071032	5907500157782	7191432	5901602346518	77626904	5905840209208	8341174	5901602362051	9143174	5901602366066	A0438	5905840202056	A1041	5901602360057		
7071174	5901602341292	7191976	5901602358368	77627904	5905840209215	8341176	5901602362068	9144174	5901602366073	A0439	5905840202063	G0122	5900805047192		

CONTACT

Dział eksportu - Export department - Abteilung für den Export

tel. +48 77 487 70 10
e-mail: export@spotlight.pl

Księgowość - Accounting - Buchhaltung

tel. +48 77 487 70 00
e-mail: ksiegowosc@spotlight.pl

Dział windykacji - Debt recovery department - Inkassoabteilung

tel. +48 77 487 70 00
e-mail: windykacja@spotlight.pl

Logistyka - Logistic department - Logistikabteilung

tel. +48 77 487 70 06
e-mail: logistyka@spotlight.pl

Dział marketingu - Marketing department - Marketingabteilung

tel. +48 77 487 70 03
e-mail: marketing@spotlight.pl

Dział inwestycji - Investment department - Investitionsabteilung

tel. +48 77 487 70 01
tel. +48 77 487 70 00 wew. 8
e-mail: inwestycje@spotlight.pl

Dział reklamacji - Complaint department - Reklamationsabteilung

tel. +48 77 487 70 04
e-mail: reklamacje@spotlight.pl

Dział technologiczny - Technological department - Technologische Abteilung

tel. +48 77 487 70 00 wew. 7
e-mail: technolog@spotlight.pl

SPOT Light Sp. z o.o.

ul. Nowe Osiedle 13D
47-240 Bierawa
Poland

Tel.: +48 77 487 70 00
Fax: +48 77 487 70 08
e-mail: spotlight@spotlight.pl



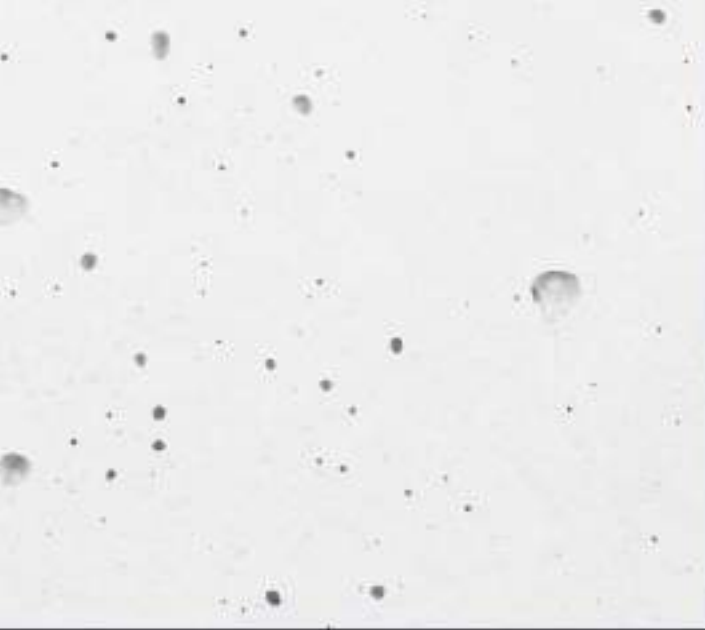

SPOT LIGHT

SPOT Light Sp. z o. o.
ul. Nowe Osiedle 13D
47-240 Bierawa
Poland

Tel.: +48 77 487 70 00
Fax: +48 77 487 70 08

e-mail: spotlight@spotlight.pl

www.spotlight.pl

